



ZENDOME.150M

Your clients love it – the event as a real experience! Communicate your MICE-activities emotionally – the geodesic dome is an inspiration with its overwhelming 150 m² of space.

ZENVISION GmbH

Prenzlauer Promenade 189
D-13198 Berlin
www.zenvision.de

T +49 30 473 776 20
F +49 30 473 776 29
info@zenvision.de

Top view:

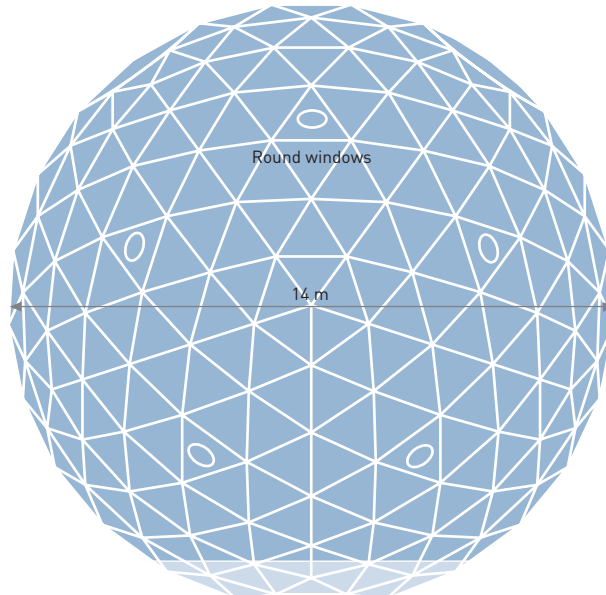

Front view:

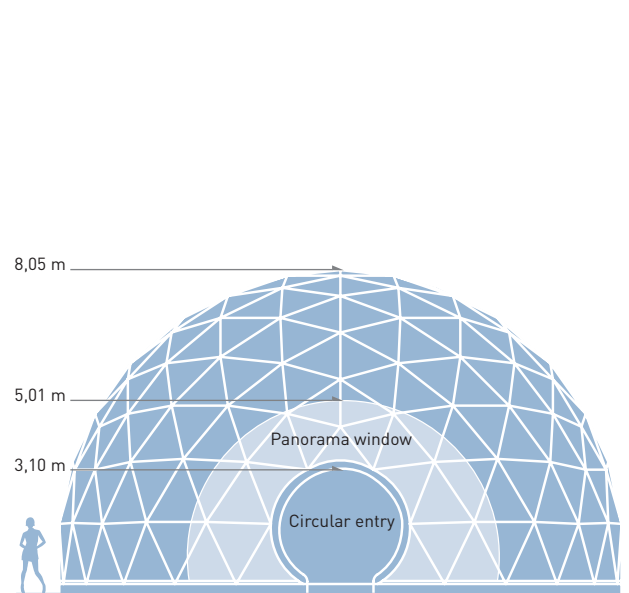

TECHNICAL DATA

Diameter	14 m
Height	8,05 m
Exhibition Space	150 m ²
Membrane Surface	294 m ²
Volume	700 m ³

ENTRANCE SETTINGS

Circular entry	1 / optional 3
Width [circular entry without door, measured at floor-level]	1,72 m
Width [circular entry without door, measured at the centre]	3,40 m
Heights of the circular-entry	3,10 m
Membrane-entrance	3
Door system (optional):	
Height of entrance with door	2,10 m
Width of entrance with door	1,07 m + 0,53 m
Door-wings	2

WINDOW SETTINGS:

Round windows	7
Round windows (transparent or white)	7
Top round windows (ventilation openings)	5
AC-openings	3
Height of panorama window	5,01 m

MATERIAL & DETAILS

Number of different struts/poles	10
Min. length of struts	1.360 mm
Max. length of struts	1.813 mm
Diameter of struts	30 mm
Material thickness	2,0 mm
Number of structure feet	25
Membrane material	PVC Coated Polyester Fabrics

SAFETY:

Windloads [dynamic pressure q = kN/m ² according to DIN 4112]	0,8
Dynamic pressure is about (Beaufort)	12 / violent storm
Extra loads	800 – 1.275 kg
Number of extra loads contact points	16 – 51

LOAD PARAMETERS

Structure	1.088 kg
Structure feet	60 kg
Membrane	220 kg
Circular doorway	31 kg
Door	95 kg
Complete	1.494 kg

LOGISTIC AND STORAGE SYSTEM

Total weight with transport stanchions	1.979 kg
Loading meters	3,2 m
Number of transport stanchions of frame system, stackable	2
Loading weight of transport stanchion of frame system and circular entry	1.359 kg
Tare weight of transport stanchion of frame system	90 kg
Transport stanchion of frame system (L x W x H)	2,02 x 0,87 x 1,14 m
Number of membrane boxes, stackable	1
Loading weight of membrane box	470 kg
Tare weight of membrane box	250 kg
Membrane box (L x W x H)	2,30 x 1,87 x 1,14 m
Number of doors per transport box	1
Loading weight of transport box of door	150 kg
Tare weight of transport box of door	55 kg
Transport box of door (L x W x H)	2,35 x 1,50 x 0,35 m

CONSTRUCTION / DECONSTRUCTION

Construction time	11 – 14 h
Deconstruction time	6 – 7 h
Team size [pax]	6 – 8
Coaching [days]	2
Mobile Crane, Height / Boom	25 m / 20 m

ZENDOME PLUG-IN

Ring nut inner diameter	2,5 cm
Number of plug-in use of half load (25 kg)	51
Number of plug-in use of full load (50 kg)	16

NOTES:

- The construction time is timed with an experienced team. For first construction calculate double the time
- Anchoring according to static calculations (earth anchors, heavy-load floor-system or loads) necessary.
- All sizes, weights and volumes listed in this table are rounded approximations and may deviate due to varying materials or production processes.



ZENDOME.150M / CIRCULAR DOORWAY

The first impression convinces guests and clients – with the two winged door by ZENDOME you will create the perfect entrance situation.

ZENVISION GmbH

Prenzlauer Promenade 189
D-13198 Berlin
www.zenvision.de

T +49 30 473 776 20
F +49 30 473 776 29
info@zenvision.de

Front view:

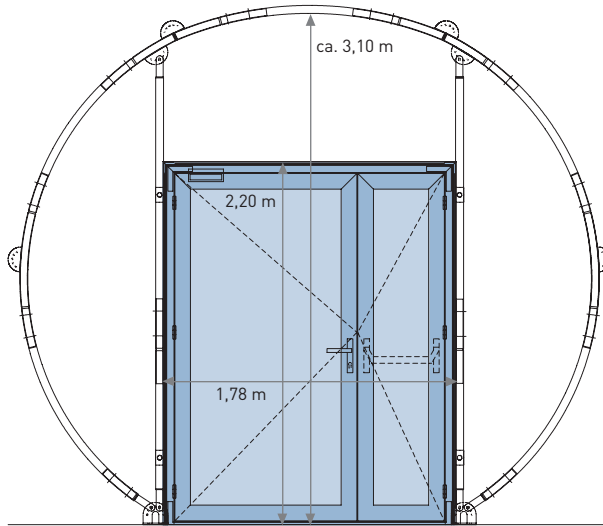

Side view:

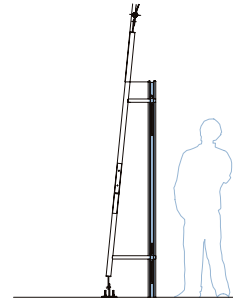

Doormat:

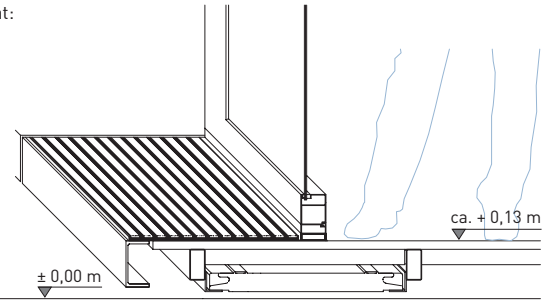

ENTRANCE SETTINGS

Circular entry	1 (3)
Width (circular entry without door, measured at floor-level)	1,72 m
Width (circular entry without door, measured at the centre)	3,40 m
Heights of the circular entry	3,10 m
Membrane-entrance	3

DOOR SYSTEM (OPTIONAL)

Height of entrance with door	2,10 m
Width of entrance with door	1,07 + 0,53 m
Width (with door, measured at floor-level)	1,60 m
Door-wings	2

MATERIAL & DETAILS

Circular entry	Stainless steel, powder-coated
Vertical and horizontal poles	Stainless steel, powder-coated
Door profiles	Aluminium
Door filling	Makrolon® clear / white
Door closer	yes
Push bar	yes
Doormat, attachment for connecting door to floor panel	1,79 x 0,52 m

LOAD PARAMETERS

Weight door	95 kg
Measurements transport box door (one door)	2,35 x 1,83 x 0,35 m
Weight / volume transport box door (one door)	55 kg / 1,50 m³
Total weight / volume	150 kg / 1,50 m³
Weight circular entry	31 kg
Loading	On strut stanchions

NOTES:

- Presented drawings are to express system and deviate in reality. All sizes, weights and volumes listed in this table are rounded approximations and may deviate due to varying materials or production processes.



ZENDOME.150M / FLOORSYSTEM

Flexible weights let the ZENDOME.floorsystem adjust to different construction situations. Invisible and adjustable as a stable basis for successful events.

Top view:

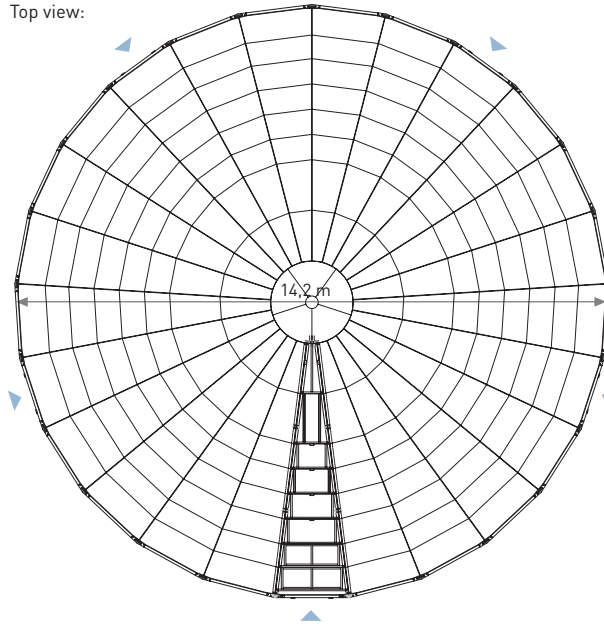

SPACE

Diameter floor-system	14,2 m
Height floor-system (without underpinning)	0,13 m
Length of ramps	3,2 m

MATERIAL & DETAILS

Substructure	Steel galvanised
Ground plates	Multiplex, 21 mm, sealed edges
Number of segments	25
Number of ground boxes	200
Middle circle	six pieces
Number of radial beams	75
Number of outer beams	25
Number of foot boxes	25
Number of base discs / points of support	85

ZENVISION GmbH

Prenzlauer Promenade 189
D-13198 Berlin
www.zenvision.de

T +49 30 473 776 20
F +49 30 473 776 29
info@zenvision.de

Section boundary area:

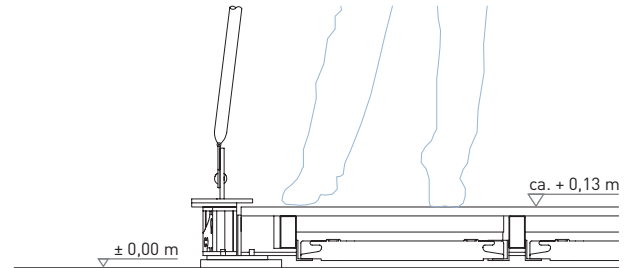

Floor plan boundary area:

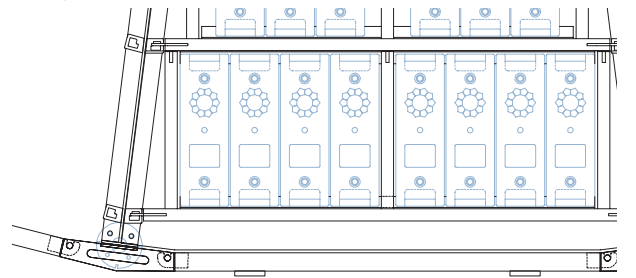

LOADING PARAMETER

Weight of heavy-load floor-system	8.000 kg
Total weight of packed heavy-load floor-system	9.080 kg
Loading meter of heavy-load floor-system	6,5 m
Number of transport stanchions, stackable	10
Transport stanchion (L x W x H)	2,28 x 1,22 x 1,14 m
Tare weight of transport stanchion	108 kg
Necessary additional loads (DIN 4112)	270 x 25 kg
Total weight of heavy-load floor-system w. add. loads	14.750 kg
Number of possible ramps	1 - 3

ASSEMBLING & DISMANTLING

Assembling time	4 - 6 h
Dismantling time	3 - 5 h
Team size (pax)	6 - 8

NOTES:

- The construction time refers to an experienced team. For first construction you need to calculate a longer construction time.
- In order to unload the transport rack a fork lift with min. 1500 kg load capacity is required.
- Maximum windload according to DIN 4112. According to the location and local building laws additional weights to secure system may be needed.
- Presented drawings are to express system and deviate in reality. All sizes, weights and volumes listed in this table are rounded approximations and may deviate due to varying materials or production processes.



ZENDOME / HOME-EDITION, MODULAR / EXTRAS

For the perfect presentation surface, secure and with style:
Special Plug-Ins for the easy installation of audio, light and design elements.

ZENVISION GmbH

Prenzlauer Promenade 189
D-13198 Berlin
www.zenvision.de

T +49 30 473 776 20
F +49 30 473 776 29
info@zenvision.de

PLUG IN WITH INTERSECTION DISC:

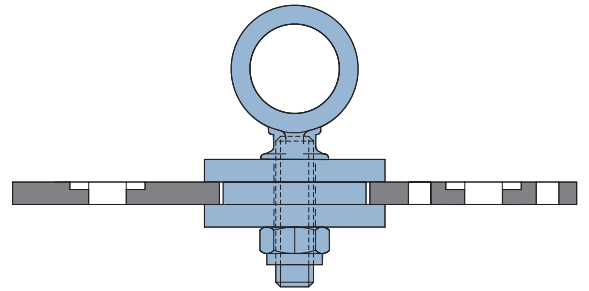
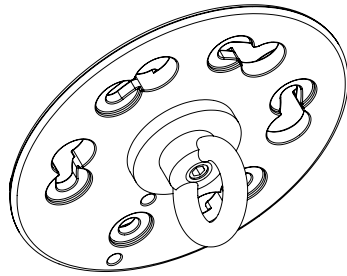

ZENDOME PLUG-IN	ZD.20HE	ZD.30M	ZD.45M	ZD.75M	ZD.150M	ZD.300M
Dimensions outside	4,5 cm	4,5 cm	4,5 cm	4,5 cm	4,5 cm	4,5 cm
Dimensions inside	2,5 cm	2,5 cm	2,5 cm	2,5 cm	2,5 cm	2,5 cm
Number of plug-in use of half load (25 kg)	16	16	16	31	51	51
Number of plug-in use of full load (50 kg)	6	6	6	11	16	20

ADDITIONAL LOAD:

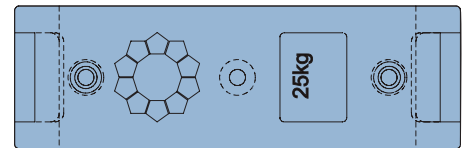
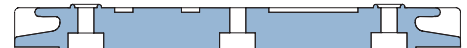
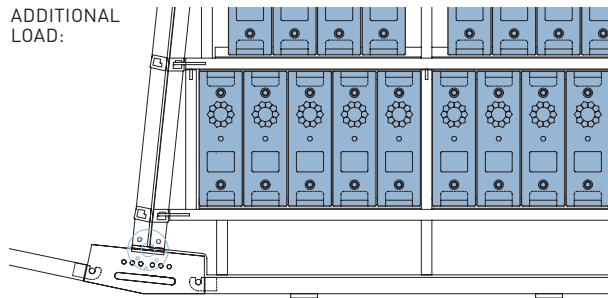

ADDITIONAL LOADS	ZD.20HE	ZD.30M	ZD.45M	ZD.75M	ZD.150M	ZD.300M
Number	x	x	80 x 25 kg	144 x 25 kg	270 x 25 kg	600 x 25 kg

ANCHOR PLATE:

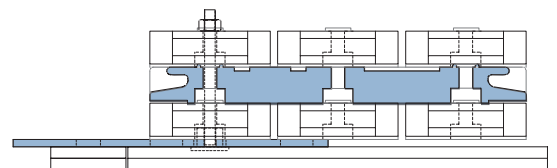
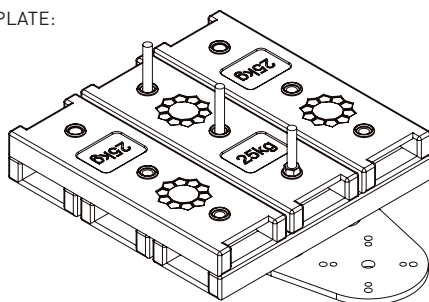

ANCHOR PLATES	ZD.20HE	ZD.30M	ZD.45M	ZD.75M	ZD.150M	ZD.300M
Number	15	15	15	20	25	30

NOTES:

- Presented drawings are to express system and deviate in reality. All sizes, weights and volumes listed in this table are rounded approximations and may deviate due to varying materials or production processes.



ZENDOME / HOME-EDITION, MODULAR / EXTRAS

Design for everyone: The ramp solution for the ZENDOME provides a safe, easy and barrier free entry to the 'Space for Ideas'.

ZENVISION GmbH

Prenzlauer Promenade 189
D-13198 Berlin
www.zenvision.de

T +49 30 473 776 20
F +49 30 473 776 29
info@zenvision.de

SMALL RAMP, top view:

BIG RAMP, top view:

RAMP, side view:

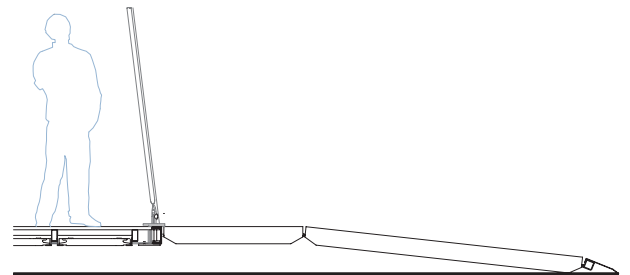
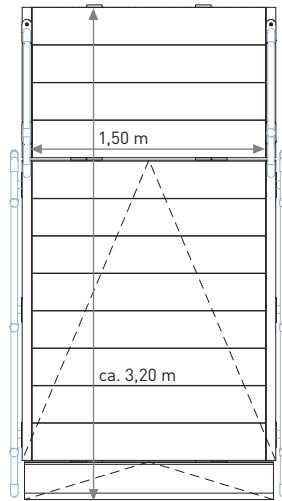
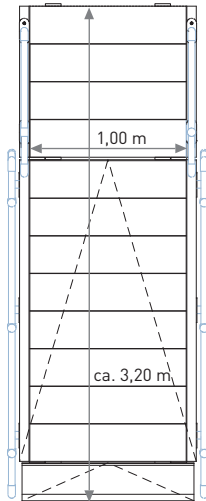

SMALL RAMP

Number of parts	3
Total length	ca. 3,20 m
Hand rail	possible

LOAD PARAMETERS

Dimensions (without euro-pallet)	1,13 x 1,97 x 0,24 m
Weight / volume (without euro-pallet)	200 kg / 0,53 m ³

BIG RAMP

Number of parts	3
Total length	ca. 3,20 m
Hand rail	possible

LOAD PARAMETERS

Dimensions (without euro-pallet)	1,63 x 1,97 m x 0,24 m
Weight / volume (without euro-pallet)	250 kg / 0,77 m ³

SMALL AND BIG FLOOR SYSTEM TUNNEL, top view:

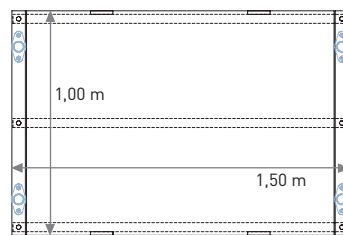
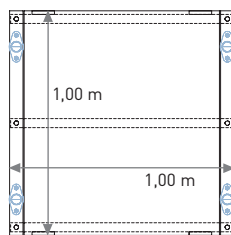

TUNNEL:

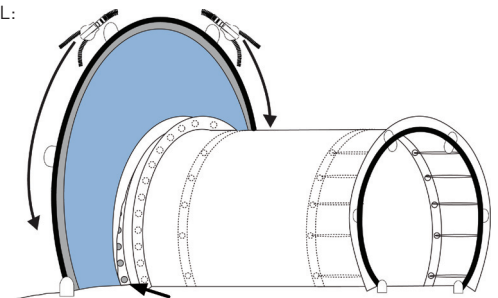

SMALL FLOOR SYSTEM TUNNEL

Number of parts	1
Total length	1 m
Hand rail	possible

LOAD PARAMETERS

Dimensions (without euro-pallet)	1,00 x 1,00 x 0,12 m
Weight / volume (without euro-pallet)	41 kg / 0,12 m ³

BIG FLOOR SYSTEM TUNNEL

Number of parts	1
Total length	1 m
Hand rail	possible

LOAD PARAMETERS

Dimensions (without euro-pallet)	1,00 x 1,50 x 0,12 m
Weight / volume (without euro-pallet)	51 kg / 0,18 m ³

TUNNEL

Membrane of tunnel	polyester fabric (PVC coated)
Reduction	polyester fabric (PVC coated)
Attachment of tunnel	Touch fastener, tightening straps

© ZENDOME 2006-2010. We kindly ask for your understanding that files and content is legal property of ZENDOME GmbH. You are not allowed to transfer data or content to third parties nor copying files and content without written permission of ZENDOME GmbH.

NOTES:

- Presented drawings are to express system and deviate in reality. All sizes, weights and volumes listed in this table are rounded approximations and may deviate due to varying materials or production processes.



ZENDOME / HOME-EDITION, MODULAR / LOGISTIC & STORAGE

The stackable transport stanchions offer perfect protection for the structure system and guarantee the longevity of the entire system.

ZENVISION GmbH

Prenzlauer Promenade 189
D-13198 Berlin
www.zenvision.de

T +49 30 473 776 20
F +49 30 473 776 29
info@zenvision.de

SMALL FRAME STANCHION, longitudinal section:

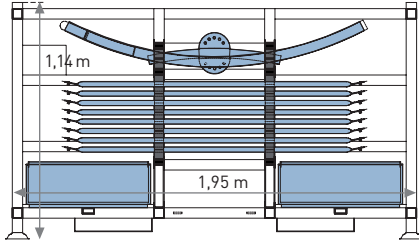

SMALL FRAME STANCHION

Dimensions	2,02 x 0,87 x 1,14 m
Weight / volume	90 kg / 2,00 m ³

SMALL FRAME STANCHION, cross section:

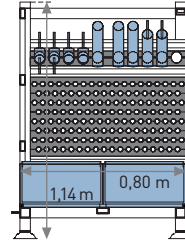

TRANSPORT BOXES

1 x big box	0,80 x 0,60 x 0,22 m
2 x small boxes	0,60 x 0,40 x 0,22 m

BIG FRAME STANCHION, longitudinal section:

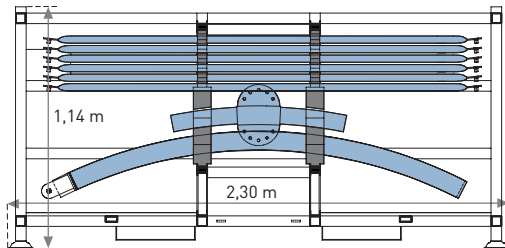

BIG FRAME STANCHION

Dimensions	2,37 x 0,87 x 1,14 m
Weight / volume	98 kg / 2,35 m ³

BIG FRAME STANCHION, cross section:

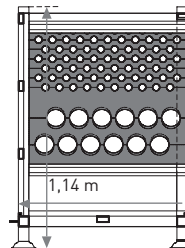

TRANSPORT BOXES

1 x big box	0,80 x 0,60 x 0,22 m
2 x small boxes	0,60 x 0,40 x 0,22 m

FLOOR STANCHION, longitudinal section:

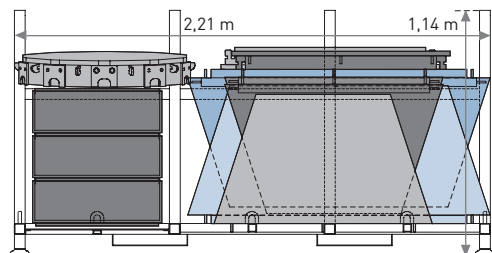

FLOOR STANCHION

Dimensions	2,28 x 1,22 x 1,14 m
Weight / volume	108 kg / 3,17 m ³

FLOOR STANCHION, cross section:

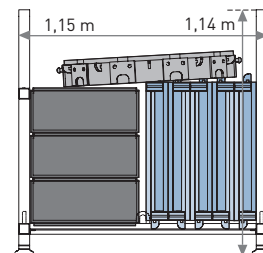

TRANSPORT BOXES

8 x boxes	0,60 x 0,40 x 0,22 m
-----------	----------------------

NOTE:

- Presented drawings are to express system and deviate in reality. All sizes, weights and volumes listed in this table are rounded approximations and may deviate due to varying materials or production processes.



ZENDOME / HOME-EDITION, MODULAR / LOGISTIC & STORAGE
Ideal protection and practical work flow by providing the possibility to lift the membrane in and out of the box directly with the crane.

ZENVISION GmbH Prenzlauer Promenade 189 T +49 30 473 776 20
D-13198 Berlin F +49 30 473 776 29
www.zenvision.de info@zenvision.de

SMALL MEMBRANE BOX, longitudinal section:

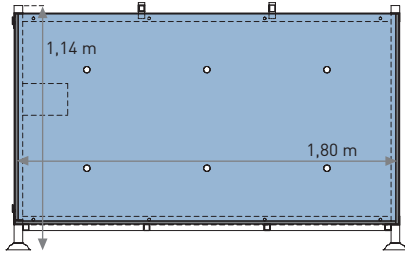

SMALL MEMBRANE BOX, cross section:

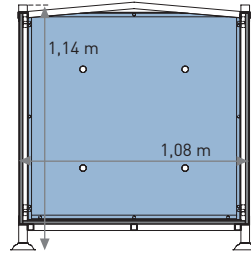

SMALL MEMBRANE BOX

Dimensions	1,15 x 1,875 x 1,14 m
Weight / volume	110 kg / 2,45 m ³

LARGE MEMBRANE BOX, cross section:

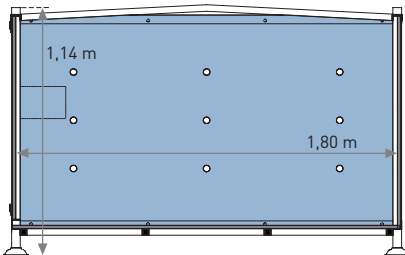

LARGE MEMBRANE BOX, floor plan:

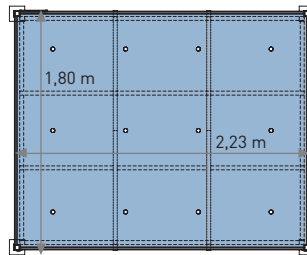

LARGE MEMBRANE BOX

Dimensions	2,30 x 1,875 x 1,14 m
Weight / volume	250 kg / 4,91 m ³

NOTE:

- Presented drawings are to express system and deviate in reality. All sizes, weights and volumes listed in this table are rounded approximations and may deviate due to varying materials or production processes.



ZENDOME / HOME-EDITION, MODULAR / LOGISTIC & STORAGE
The entire system for the safe and easy transport. With our special adapter you will grab anything you might need for the ZENDOME.doors.

ZENVISION GmbH Prenzlauer Promenade 189 T +49 30 473 776 20
D-13198 Berlin F +49 30 473 776 29
www.zenvision.de info@zenvision.de

DOOR STANCHION, longitudinal section:

DOOR STANCHION, cross section:

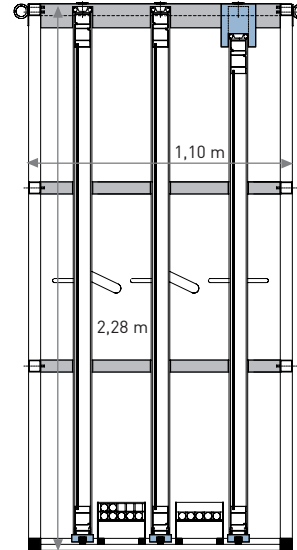
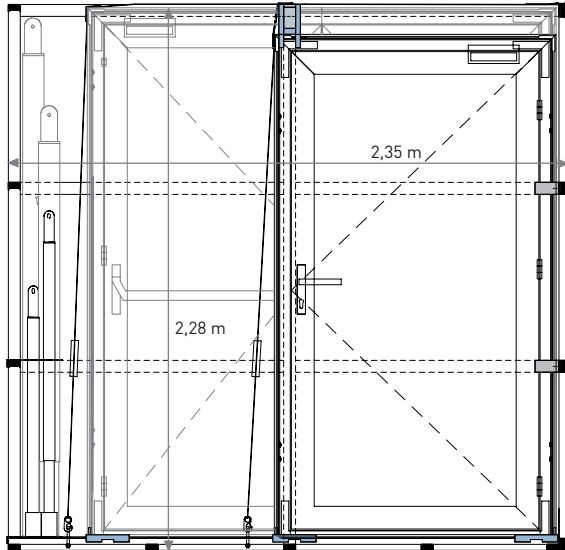

DOOR STANCHION

Dimensions	2,35 x 1,10 x 2,28 m
Weight / volume	ca. 290 kg / 5,89 m ³

NOTE:

- Presented drawings are to express system and deviate in reality. All sizes, weights and volumes listed in this table are rounded approximations and may deviate due to varying materials or production processes.