



**ZENDOME.20HE**

For Wellness and Relaxation: the Home Edition will enhance your life. 20 m<sup>2</sup> of exclusive space on land, on water pontoons, as workshop, tea- or even temporary guest house.

ZENVISION GmbH

Prenzlauer Promenade 189  
D-13198 Berlin  
www.zenvision.de

T +49 30 473 776 20  
F +49 30 473 776 29  
info@zenvision.de

Top view:

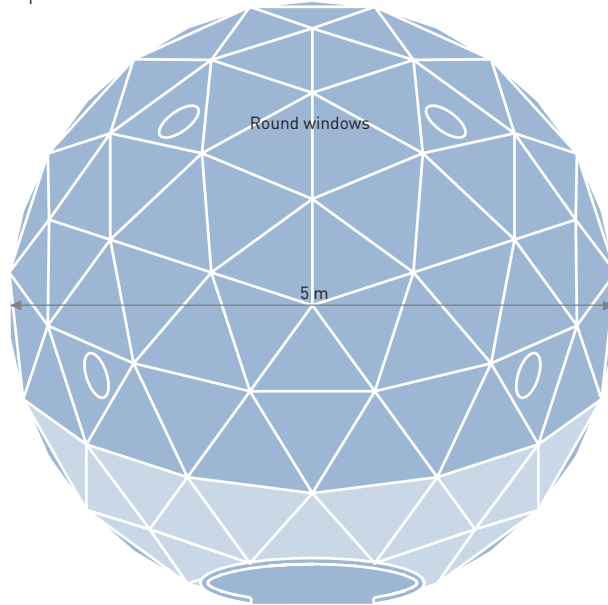

Front view:

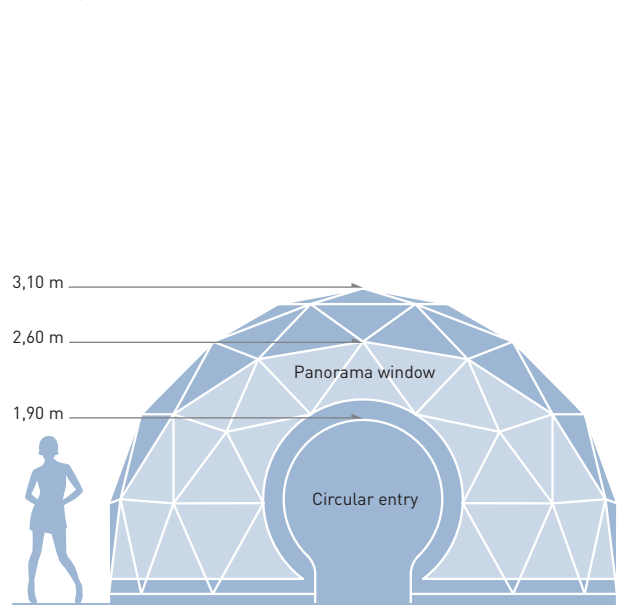

**TECHNICAL DATA**

Diameter	5 m
Height	3,10 m
Exhibition Space	20 m <sup>2</sup>
Membrane Surface	39 m <sup>2</sup>
Volume	40 m <sup>3</sup>

**ENTRANCE SETTINGS**

Circular entry	1
Width [circular entry without door, measured at floor-level]	0,86 m
Width [circular entry without door, measured at the centre]	1,92 m
Heights of the circular-entry	1,90 m
Membrane-entrance	1

**WINDOW SETTINGS:**

Round windows	4
Round windows (transparent or white)	4
Top round windows (ventilation openings)	-
AC-openings	-
Height of panorama window	2,60 m

**MATERIAL & DETAILS**

Number of different struts/poles	5
Min. length of struts	817 mm
Max. length of struts	987 mm
Diameter of struts	25 mm
Material thickness	2,0 mm
Number of structure feet	15
Membrane material	PVC Coated Polyester Fabrics

**SAFETY:**

Windloads [dynamic pressure q = kN/m <sup>2</sup> according to DIN 4112]	0,5
Dynamic pressure is about [Beaufort]	11 / violent storm
Extra loads	300 – 400 kg
Number of extra loads contact points	6 – 16

**LOAD PARAMETERS**

Structure	222 kg
Structure feet	36 kg
Membrane	30 kg
Circular doorway	18 kg
Door	-
Complete	306 kg

**LOGISTIC AND STORAGE SYSTEM**

Total weight with euro-pallets and packing material	350 kg
Loading meters	0,8 m
Number of euro-pallets with packaging carton for frame system	1
Loading weight euro-pallets with frame system and circular entry	298 kg
Euro-pallet with packaging carton (L x W x H)	1,20 x 0,80 x 0,80 m
Number of euro-pallets with packaging carton for membrane	1
Loading weight euro-pallets with membrane	52 kg
Euro-pallet with packaging carton (L x W x H)	1,20 x 0,80 x 0,80 m

**CONSTRUCTION / DECONSTRUCTION**

Construction time	2 – 3 h
Deconstruction time	1 – 2 h
Team size [pax]	2 – 3
Coaching [days]	1
Mobile Crane, Height / Boom	-

**ZENDOME PLUG-IN**

Ring nut inner diameter	2,5 cm
Number of plug-in use of half load [25 kg]	16
Number of plug-in use of full load [50 kg]	6

**NOTES:**

- The construction time is timed with an experienced team. For first construction calculate double the time
- Anchoring according to static calculations (earth anchors, heavy-load floor-system or loads) necessary.
- All sizes, weights and volumes listed in this table are rounded approximations and may deviate due to varying materials or production processes.



**ZENDOME.20HE / CIRCULAR DOORWAY**

The entrance perfectly completes the noble design of your exclusive ZENDOME. Elegant and without edges, made from stainless steel and easily constructed.

ZENVISION GmbH Prenzlauer Promenade 189 T +49 30 473 776 20  
D-13198 Berlin F +49 30 473 776 29  
www.zenvision.de info@zenvision.de

Front view:

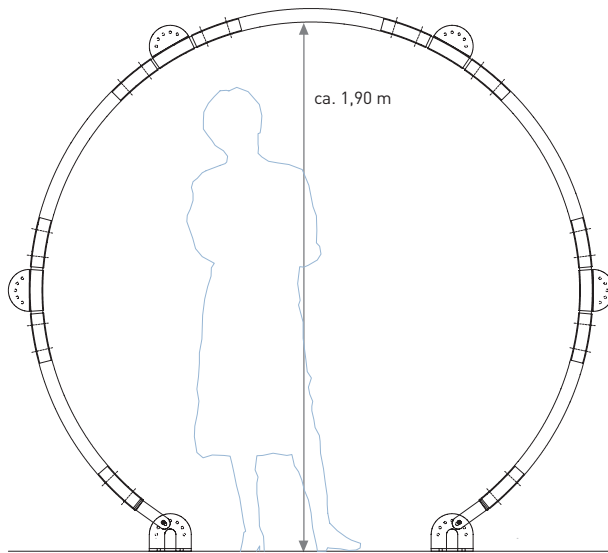

Side view:

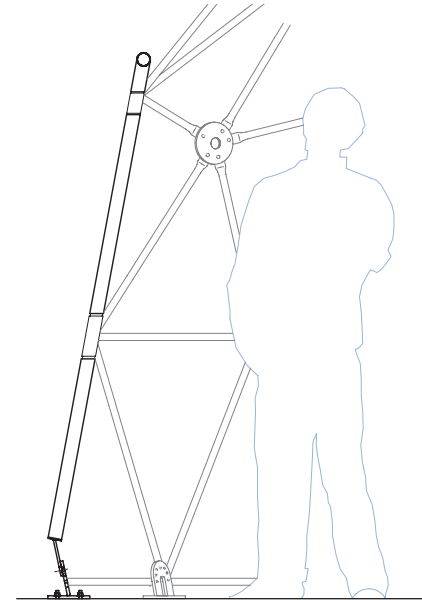

**ENTRANCE SETTINGS**

Circular entry	1
Width (circular entry without door, measured at floor-level)	0,86 m
Width (circular entry without door, measured at the centre)	1,92 m
Heights of the circular entry	1,90 m
Membrane-entrance	1

**MATERIAL & DETAILS**

Circular entry	Stainless steel, powder-coated
----------------	--------------------------------

**LOAD PARAMETERS**

Weight circular entry	18 kg
Loading	On euro-pallet

**NOTE:**

- Presented drawings are to express system and deviate in reality. All sizes, weights and volumes listed in this table are rounded approximations and may deviate due to varying materials or production processes.



**ZENDOME.20HE / FLOORSYSTEM**

Elegant and stylish: The ZENDOME.floorsystem for the exclusive Home & Garden will complete your dream of a guest-, garden- or children play house.

ZENVISION GmbH

Prenzlauer Promenade 189  
D-13198 Berlin  
www.zenvision.de

T +49 30 473 776 20  
F +49 30 473 776 29  
info@zenvision.de

Top view:

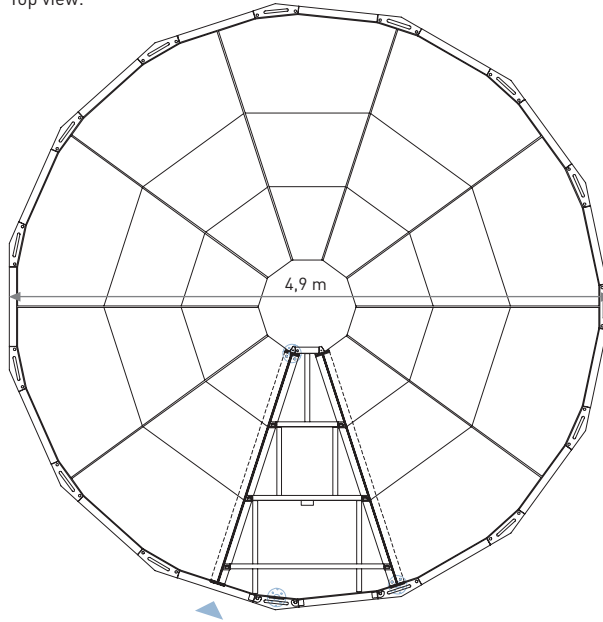

Section boundary area:

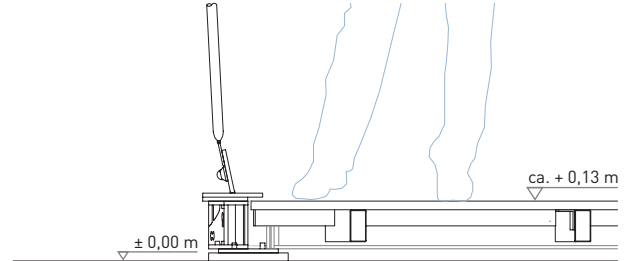

Floor plan boundary area:

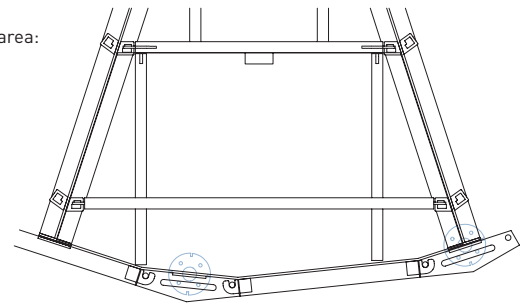

**SPACE**

Diameter floor-system	4,9 m
Height floor-system (without underpinning)	0,13 m
Length of ramps	3,2 m

**MATERIAL & DETAILS**

Substructure	steel galvanised
Ground plates	Multiplex, 21 mm, sealed edges
Number of segments	10
Number of ground boxes	30
Middle circle	one piece
Number of radial beams	10
Number of outer beams	15
Number of foot boxes	15
Number of base discs / points of support	18

**LOADING PARAMETER**

Weight of heavy-load floor-system	1.150 kg
Total weight of packed heavy-load floor-system	1.366 kg
Loading meter of heavy-load floor-system	1,3 m
Number of transport stanchions, stackable	2
Transport stanchion (L x W x H)	2,28 x 1,22 x 1,14 m
Tare weight of transport stanchion	108 kg
Necessary additional loads (DIN 4112)	-
Total weight of heavy-load floor-system w. additional loads	-
Number of possible ramps	1

**ASSEMBLING & DISMANTLING**

Assembling time	2 – 3 h
Dismantling time	1 – 2 h
Team size (pax)	2 – 3

**NOTES:**

- The construction time refers to an experienced team. For first construction you need to calculate a longer construction time.
- In order to unload the transport rack a fork lift with min. 1500 kg load capacity is required.
- According to the location and local building laws anchoring to secure system may be needed.
- Presented drawings are to express system and deviate in reality. All sizes, weights and volumes listed in this table are rounded approximations and may deviate due to varying materials or production processes.



**ZENDOME / HOME-EDITION, MODULAR / EXTRAS**

For the perfect presentation surface, secure and with style:  
Special Plug-Ins for the easy installation of audio, light and design elements.

ZENVISION GmbH

Prenzlauer Promenade 189  
D-13198 Berlin  
www.zenvision.de

T +49 30 473 776 20  
F +49 30 473 776 29  
info@zenvision.de

**PLUG IN WITH INTERSECTION DISC:**

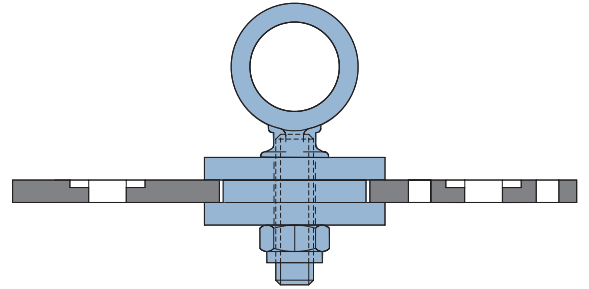
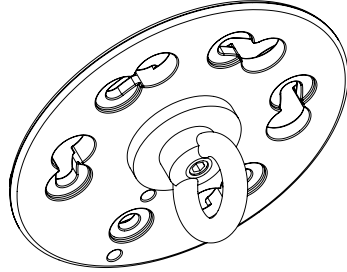

ZENDOME PLUG-IN	ZD.20HE	ZD.30M	ZD.45M	ZD.75M	ZD.150M	ZD.300M
Dimensions outside	4,5 cm	4,5 cm	4,5 cm	4,5 cm	4,5 cm	4,5 cm
Dimensions inside	2,5 cm	2,5 cm	2,5 cm	2,5 cm	2,5 cm	2,5 cm
Number of plug-in use of half load (25 kg)	16	16	16	31	51	51
Number of plug-in use of full load (50 kg)	6	6	6	11	16	20

**ADDITIONAL LOAD:**

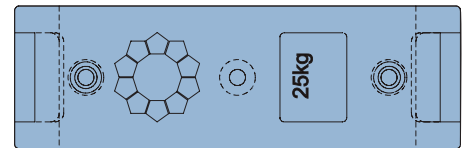
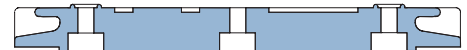
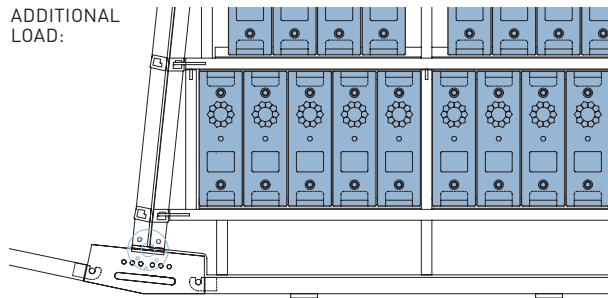

ADDITIONAL LOADS	ZD.20HE	ZD.30M	ZD.45M	ZD.75M	ZD.150M	ZD.300M
Number	x	x	80 x 25 kg	144 x 25 kg	270 x 25 kg	600 x 25 kg

**ANCHOR PLATE:**

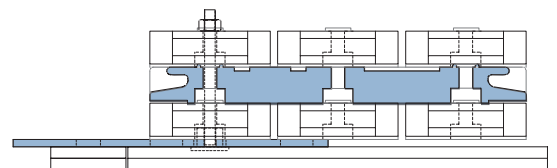
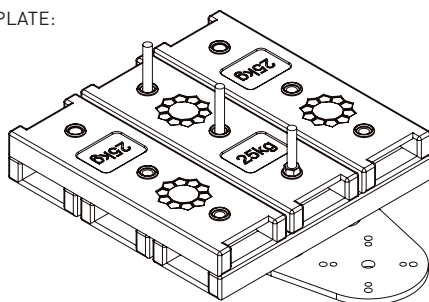

ANCHOR PLATES	ZD.20HE	ZD.30M	ZD.45M	ZD.75M	ZD.150M	ZD.300M
Number	15	15	15	20	25	30

**NOTES:**

- Presented drawings are to express system and deviate in reality. All sizes, weights and volumes listed in this table are rounded approximations and may deviate due to varying materials or production processes.



**ZENDOME / HOME-EDITION, MODULAR / EXTRAS**

Design for everyone: The ramp solution for the ZENDOME provides a safe, easy and barrier free entry to the 'Space for Ideas'.

ZENVISION GmbH

Prenzlauer Promenade 189  
D-13198 Berlin  
www.zenvision.de

T +49 30 473 776 20  
F +49 30 473 776 29  
info@zenvision.de

SMALL RAMP, top view:

BIG RAMP, top view:

RAMP, side view:

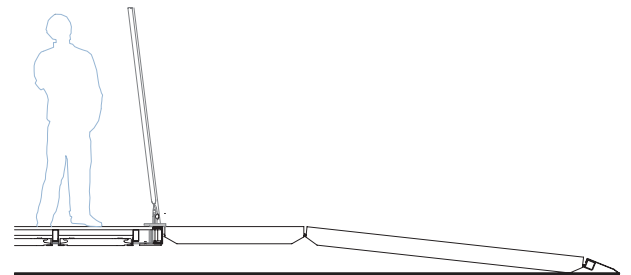
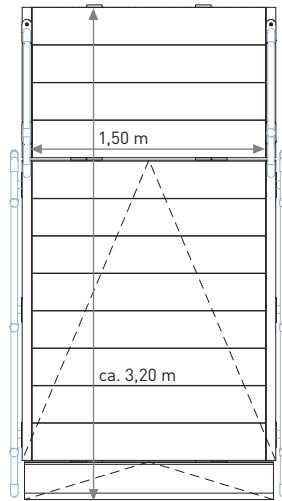
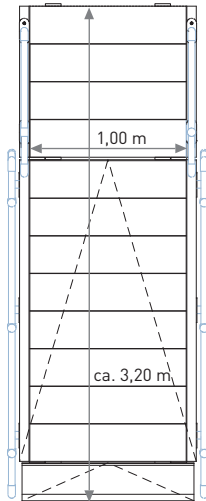

**SMALL RAMP**

Number of parts	3
Total length	ca. 3,20 m
Hand rail	possible

**LOAD PARAMETERS**

Dimensions (without euro-pallet)	1,13 x 1,97 x 0,24 m
Weight / volume (without euro-pallet)	200 kg / 0,53 m <sup>3</sup>

**BIG RAMP**

Number of parts	3
Total length	ca. 3,20 m
Hand rail	possible

**LOAD PARAMETERS**

Dimensions (without euro-pallet)	1,63 x 1,97 m x 0,24 m
Weight / volume (without euro-pallet)	250 kg / 0,77 m <sup>3</sup>

SMALL AND BIG FLOOR SYSTEM TUNNEL, top view:

TUNNEL:

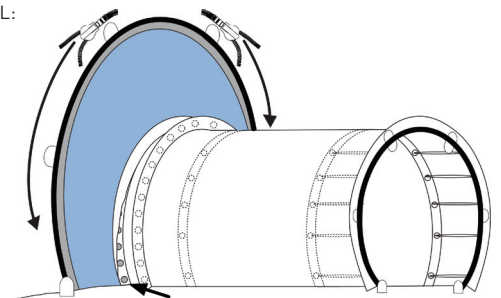
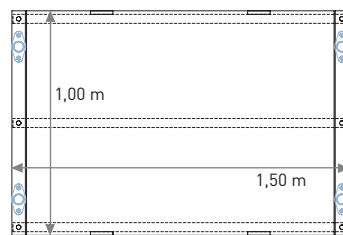
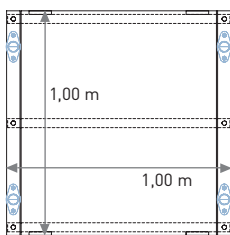

**SMALL FLOOR SYSTEM TUNNEL**

Number of parts	1
Total length	1 m
Hand rail	possible

**LOAD PARAMETERS**

Dimensions (without euro-pallet)	1,00 x 1,00 x 0,12 m
Weight / volume (without euro-pallet)	41 kg / 0,12 m <sup>3</sup>

**BIG FLOOR SYSTEM TUNNEL**

Number of parts	1
Total length	1 m
Hand rail	possible

**LOAD PARAMETERS**

Dimensions (without euro-pallet)	1,00 x 1,50 x 0,12 m
Weight / volume (without euro-pallet)	51 kg / 0,18 m <sup>3</sup>

**TUNNEL**

Membrane of tunnel	polyester fabric (PVC coated)
Reduction	polyester fabric (PVC coated)
Attachment of tunnel	Touch fastener, tightening straps

© ZENDOME 2006-2010. We kindly ask for your understanding that files and content is legal property of ZENDOME GmbH. You are not allowed to transfer data or content to third parties nor copying files and content without written permission of ZENDOME GmbH.

**NOTES:**

- Presented drawings are to express system and deviate in reality. All sizes, weights and volumes listed in this table are rounded approximations and may deviate due to varying materials or production processes.



**ZENDOME / HOME-EDITION, MODULAR / LOGISTIC & STORAGE**

The stackable transport stanchions offer perfect protection for the structure system and guarantee the longevity of the entire system.

ZENVISION GmbH

Prenzlauer Promenade 189  
D-13198 Berlin  
www.zenvision.de

T +49 30 473 776 20  
F +49 30 473 776 29  
info@zenvision.de

SMALL FRAME STANCHION, longitudinal section:

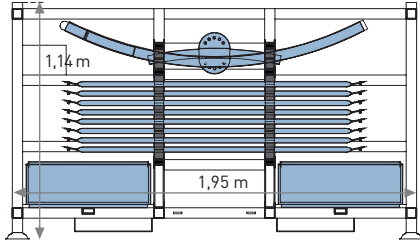

**SMALL FRAME STANCHION**

Dimensions	2,02 x 0,87 x 1,14 m
Weight / volume	90 kg / 2,00 m <sup>3</sup>

SMALL FRAME STANCHION, cross section:

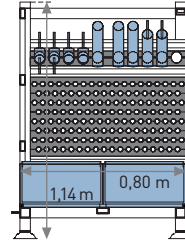

**TRANSPORT BOXES**

1 x big box	0,80 x 0,60 x 0,22 m
2 x small boxes	0,60 x 0,40 x 0,22 m

BIG FRAME STANCHION, longitudinal section:

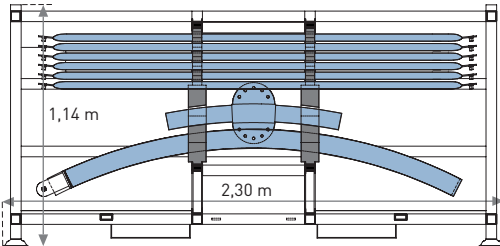

**BIG FRAME STANCHION**

Dimensions	2,37 x 0,87 x 1,14 m
Weight / volume	98 kg / 2,35 m <sup>3</sup>

BIG FRAME STANCHION, cross section:

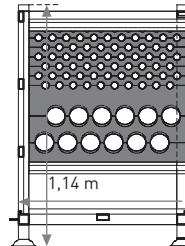

**TRANSPORT BOXES**

1 x big box	0,80 x 0,60 x 0,22 m
2 x small boxes	0,60 x 0,40 x 0,22 m

FLOOR STANCHION, longitudinal section:

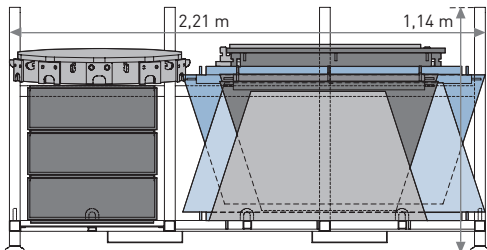

**FLOOR STANCHION**

Dimensions	2,28 x 1,22 x 1,14 m
Weight / volume	108 kg / 3,17 m <sup>3</sup>

FLOOR STANCHION, cross section:

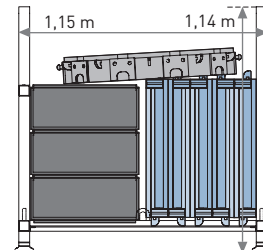

**TRANSPORT BOXES**

8 x boxes	0,60 x 0,40 x 0,22 m
-----------	----------------------

**NOTE:**

- Presented drawings are to express system and deviate in reality. All sizes, weights and volumes listed in this table are rounded approximations and may deviate due to varying materials or production processes.



**ZENDOME / HOME-EDITION, MODULAR / LOGISTIC & STORAGE**  
Ideal protection and practical work flow by providing the possibility to lift the membrane in and out of the box directly with the crane.

ZENVISION GmbH Prenzlauer Promenade 189 T +49 30 473 776 20  
D-13198 Berlin F +49 30 473 776 29  
www.zenvision.de info@zenvision.de

SMALL MEMBRANE BOX, longitudinal section:

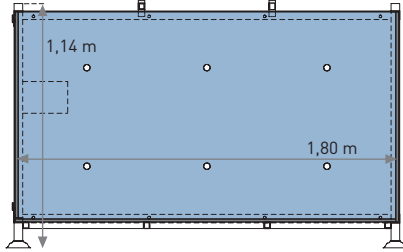

SMALL MEMBRANE BOX, cross section:

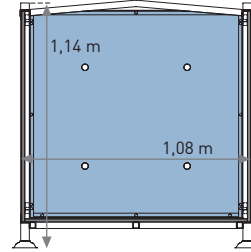

**SMALL MEMBRANE BOX**

Dimensions 1,15 x 1,875 x 1,14 m  
Weight / volume 110 kg / 2,45 m<sup>3</sup>

LARGE MEMBRANE BOX, cross section:

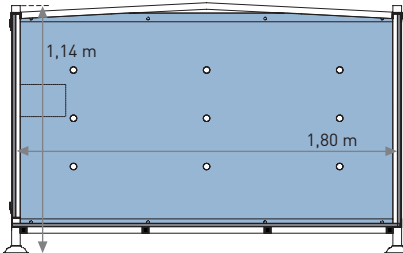

LARGE MEMBRANE BOX, floor plan:

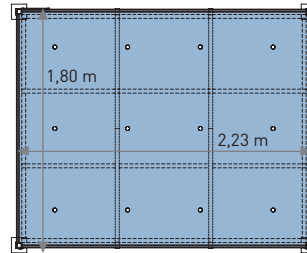

**LARGE MEMBRANE BOX**

Dimensions 2,30 x 1,875 x 1,14 m  
Weight / volume 250 kg / 4,91 m<sup>3</sup>

**NOTE:**

- Presented drawings are to express system and deviate in reality. All sizes, weights and volumes listed in this table are rounded approximations and may deviate due to varying materials or production processes.



**ZENDOME / HOME-EDITION, MODULAR / LOGISTIC & STORAGE**  
The entire system for the safe and easy transport. With our special adapter you will grab anything you might need for the ZENDOME.doors.

ZENVISION GmbH Prenzlauer Promenade 189 T +49 30 473 776 20  
D-13198 Berlin F +49 30 473 776 29  
www.zenvision.de info@zenvision.de

DOOR STANCHION, longitudinal section:

DOOR STANCHION, cross section:

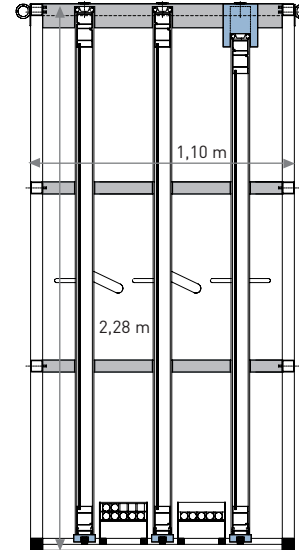
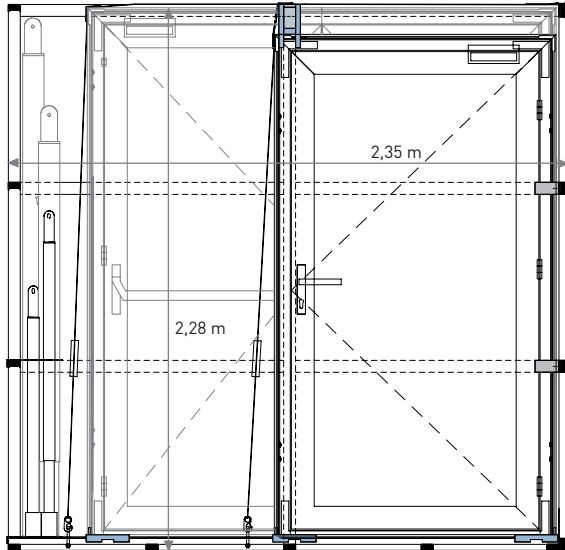

**DOOR STANCHION**

Dimensions	2,35 x 1,10 x 2,28 m
Weight / volume	ca. 290 kg / 5,89 m <sup>3</sup>

**NOTE:**

- Presented drawings are to express system and deviate in reality. All sizes, weights and volumes listed in this table are rounded approximations and may deviate due to varying materials or production processes.