

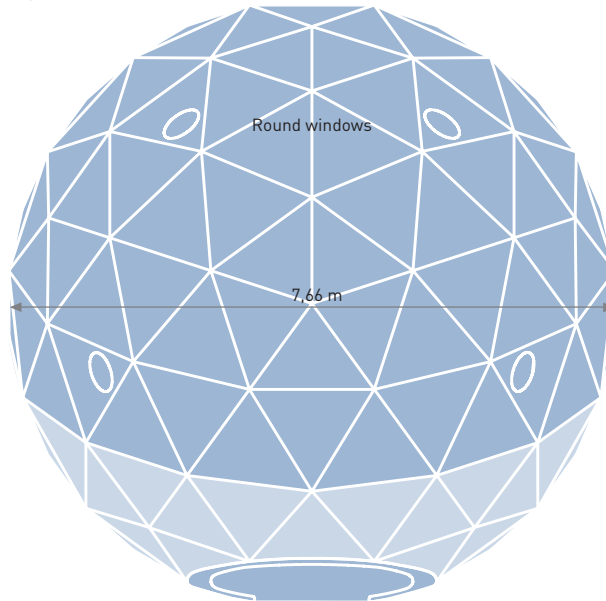

ZENDOME.45M

45 square metres of geodesic space – the perfect size for seminars, conventions, corporate events, for exclusive banquets, receptions and weddings.

Top view:



Front view:

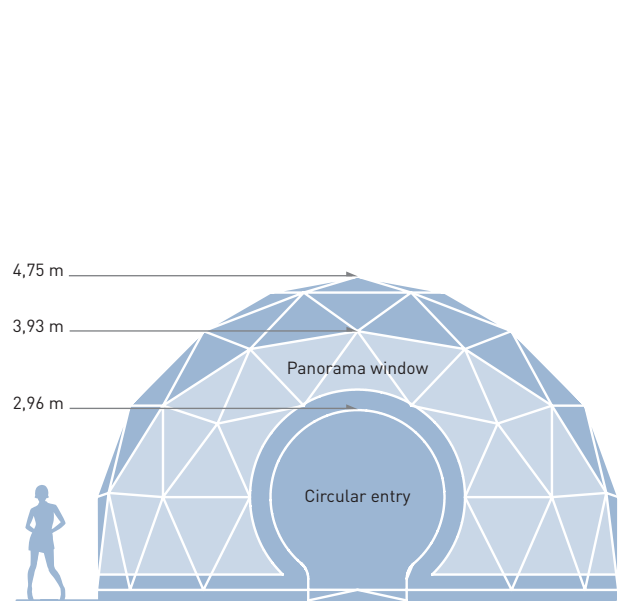

TECHNICAL DATA	
Diameter	7,66 m
Height	4,75 m
Exhibition Space	45 m ²
Membrane Surface	109 m ²
Volume	149 m ³

ENTRANCE SETTINGS	
Circular entry	1 / optional 3
Width [circular entry without door, measured at floor-level]	1,42 m
Width [circular entry without door, measured at the centre]	3,04 m
Heights of the circular-entry	2,96 m
Membrane-entrance	3
Door system (optional):	
Height of entrance with door	2,10 m
Width of entrance with door	1,27 m
Door-wings	1

WINDOW SETTINGS:	
Round windows	4
Round windows (transparent or white)	4
Top round windows (ventilation openings)	-
AC-openings	1
Height of panorama window	3,93 m

MATERIAL & DETAILS	
Number of different struts/poles	5
Min. length of struts	1,293 mm
Max. length of struts	1.559 mm
Diameter of struts	25 mm
Material thickness	2,0 mm
Number of structure feet	15
Membrane material	PVC Coated Polyester Fabrics

SAFETY:	
Windloads [dynamic pressure q = kN/m ² according to DIN 4112]	0,5
Dynamic pressure is about (Beaufort)	11 / violent storm
Extra loads	300 – 400 kg
Number of extra loads contact points	6 – 16

LOAD PARAMETERS	
Structure	315 kg
Structure feet	36 kg
Membrane	75 kg
Circular doorway	27 kg
Door	80 kg
Complete	533 kg

LOGISTIC AND STORAGE SYSTEM	
Total weight with transport stanchions	783 kg
Loading meters	2,5 m
Number of transport stanchions of frame system, stackable	1
Loading weight of transport stanchion of frame system and circular entry	468 kg
Tare weight of transport stanchion of frame system	90 kg
Transport stanchion of frame system (L x W x H)	2,02 x 0,87 x 1,14 m
Number of membrane boxes, stackable	1
Loading weight of membrane box	185 kg
Tare weight of membrane box	110 kg
Membrane box (L x W x H)	1,15 x 1,87 x 1,14 m
Number of doors per transport box	1
Loading weight of transport box of door	130 kg
Tare weight of transport box of door	50 kg
Transport box of door (L x W x H)	2,35 x 1,50 x 0,35 m

CONSTRUCTION / DECONSTRUCTION	
Construction time	4 – 5 h
Deconstruction time	2 – 3 h
Team size [pax]	2 – 3
Coaching [days]	1
Mobile Crane, Height / Boom	-

ZENDOME PLUG-IN	
Ring nut inner diameter	2,5 cm
Number of plug-in use of half load (25 kg)	16
Number of plug-in use of full load (50 kg)	6

- NOTES:**
- The construction time is timed with an experienced team. For first construction calculate double the time
 - Anchoring according to static calculations (earth anchors, heavy-load floor-system or loads) necessary.
 - All sizes, weights and volumes listed in this table are rounded approximations and may deviate due to varying materials or production processes.



ZENDOME.45M / CIRCULAR DOORWAY

Adapt the door styling of your ZENDOME.door to your event design and choose between opaque aluminium and transparent Makrolon®.

ZENVISION GmbH

Prenzlauer Promenade 189
D-13198 Berlin
www.zenvision.de

T +49 30 473 776 20
F +49 30 473 776 29
info@zenvision.de

Front view:

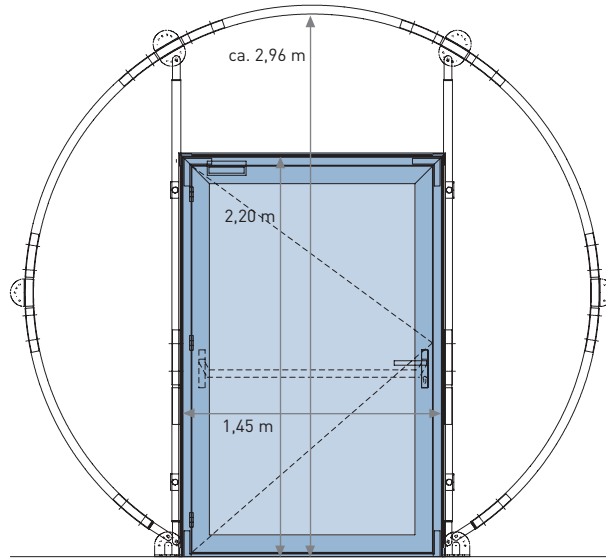

Side view:

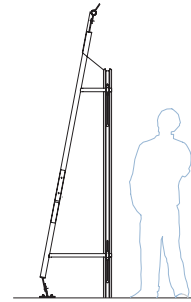

Doormat:

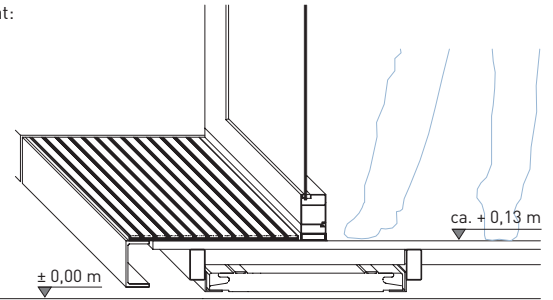

ENTRANCE SETTINGS

Circular entry	1 (3)
Width (circular entry without door, measured at floor-level)	1,42 m
Width (circular entry without door, measured at the centre)	3,04 m
Heights of the circular entry	2,96 m
Membrane-entrance	3

DOOR SYSTEM (OPTIONAL)

Height of entrance with door	2,10 m
Width of entrance with door	1,27 m
Width (with door, measured at floor-level)	1,27 m
Door-wings	1

MATERIAL & DETAILS

Circular entry	Stainless steel, powder-coated
Vertical and horizontal poles	Stainless steel, powder-coated
Door profiles	Aluminium
Door filling	Makrolon® clear / white
Door closer	yes
Push bar	yes
Doormat, attachment for connecting door to floor panel	1,48 x 0,38 m

LOAD PARAMETERS

Weight door	80 kg
Measurements transport box door (one door)	2,35 x 1,50 x 0,35 m
Weight / volume transport box door (one door)	50 kg / 1,23 m³
Total weight / volume	130 kg / 1,23 m³
Weight circular entry	27 kg
Loading	On strut stanchions

NOTES:

- Presented drawings are to express system and deviate in reality. All sizes, weights and volumes listed in this table are rounded approximations and may deviate due to varying materials or production processes.



ZENDOME.45M / FLOORSYSTEM

Safe construction, high quality material: the individual parts of the floor are pre-assembled which makes the construction easier and saves valuable time during successful events.

Top view:

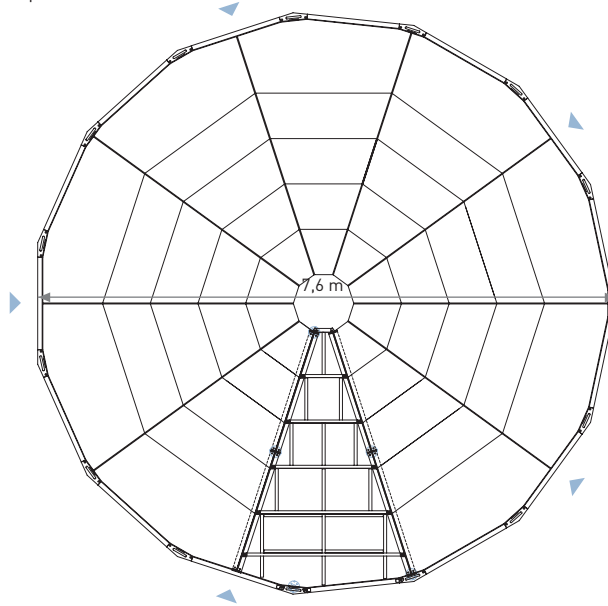

SPACE	
Diameter floor-system	7,6 m
Height floor-system (without underpinning)	0,13 m
Length of ramps	3,2 m

MATERIAL & DETAILS	
Substructure	Steel galvanised
Ground plates	Multiplex, 21 mm, sealed edges
Number of segments	10
Number of ground boxes	50
Middle circle	one piece
Number of radial beams	20
Number of outer beams	15
Number of foot boxes	15
Number of base discs / points of support	28

ZENVISION GmbH Prenzlauer Promenade 189 T +49 30 473 776 20
D-13198 Berlin F +49 30 473 776 29
www.zenvision.de info@zenvision.de

Section boundary area:

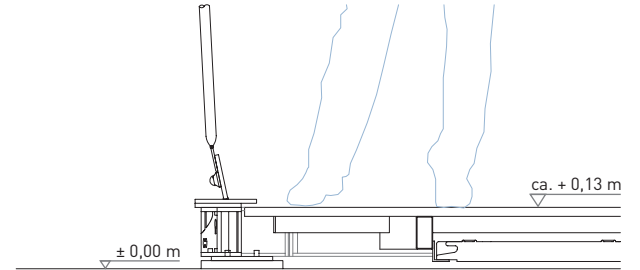

Floor plan boundary area:

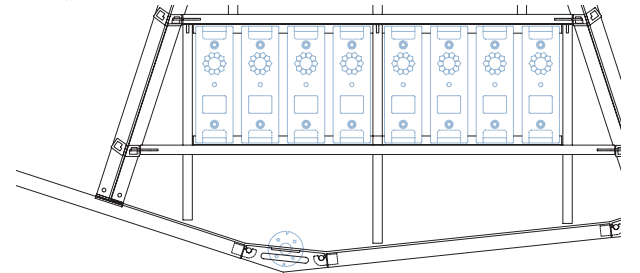

LOADING PARAMETER	
Weight of heavy-load floor-system	2.200 kg
Total weight of packed heavy-load floor-system	2.632 kg
Loading meter of heavy-load floor-system	2,6 m
Number of transport stanchions, stackable	4
Transport stanchion (L x W x H)	2,28 x 1,22 x 1,14 m
Tare weight of transport stanchion	108 kg
Necessary additional loads (DIN 4112)	80 x 25 kg
Total weight of heavy-load floor-system w. additional loads	4.200 kg
Number of possible ramps	1 – 3

ASSEMBLING & DISMANTLING	
Assembling time	2 – 3 h
Dismantling time	1 – 2 h
Team size (pax)	3 – 4

NOTES:

- The construction time refers to an experienced team. For first construction you need to calculate a longer construction time.
- In order to unload the transport rack a fork lift with min. 1500 kg load capacity is required.
- Maximum windload according to DIN 4112. According to the location and local building laws additional weights to secure system may be needed.
- Presented drawings are to express system and deviate in reality. All sizes, weights and volumes listed in this table are rounded approximations and may deviate due to varying materials or production processes.



ZENDOME / HOME-EDITION, MODULAR / EXTRAS

For the perfect presentation surface, secure and with style:
Special Plug-Ins for the easy installation of audio, light and design elements.

ZENVISION GmbH

Prenzlauer Promenade 189
D-13198 Berlin
www.zenvision.de

T +49 30 473 776 20
F +49 30 473 776 29
info@zenvision.de

PLUG IN WITH INTERSECTION DISC:

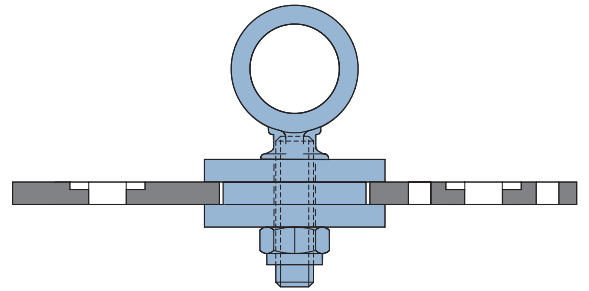
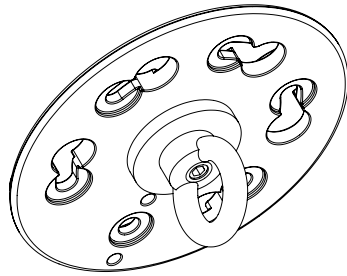

ZENDOME PLUG-IN	ZD.20HE	ZD.30M	ZD.45M	ZD.75M	ZD.150M	ZD.300M
Dimensions outside	4,5 cm	4,5 cm	4,5 cm	4,5 cm	4,5 cm	4,5 cm
Dimensions inside	2,5 cm	2,5 cm	2,5 cm	2,5 cm	2,5 cm	2,5 cm
Number of plug-in use of half load (25 kg)	16	16	16	31	51	51
Number of plug-in use of full load (50 kg)	6	6	6	11	16	20

ADDITIONAL LOAD:

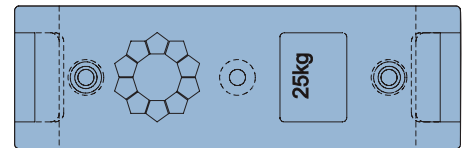
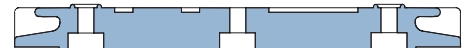
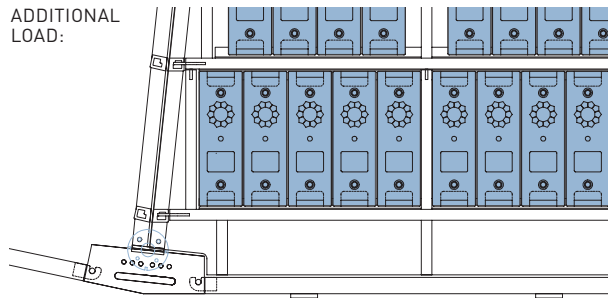

ADDITIONAL LOADS	ZD.20HE	ZD.30M	ZD.45M	ZD.75M	ZD.150M	ZD.300M
Number	x	x	80 x 25 kg	144 x 25 kg	270 x 25 kg	600 x 25 kg

ANCHOR PLATE:

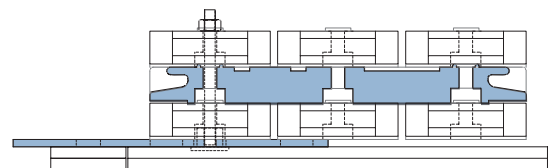
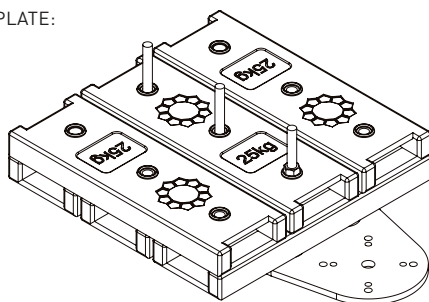

ANCHOR PLATES	ZD.20HE	ZD.30M	ZD.45M	ZD.75M	ZD.150M	ZD.300M
Number	15	15	15	20	25	30

NOTES:

- Presented drawings are to express system and deviate in reality. All sizes, weights and volumes listed in this table are rounded approximations and may deviate due to varying materials or production processes.



ZENDOME / HOME-EDITION, MODULAR / EXTRAS

Design for everyone: The ramp solution for the ZENDOME provides a safe, easy and barrier free entry to the 'Space for Ideas'.

ZENVISION GmbH

Prenzlauer Promenade 189
D-13198 Berlin
www.zenvision.de

T +49 30 473 776 20
F +49 30 473 776 29
info@zenvision.de

SMALL RAMP, top view:

BIG RAMP, top view:

RAMP, side view:

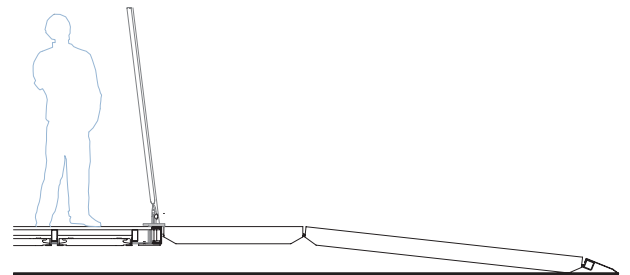
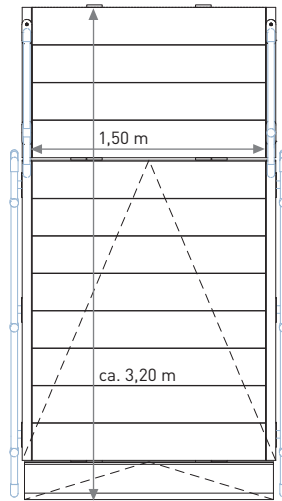
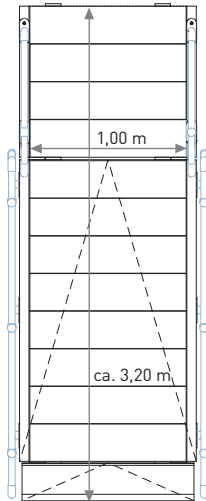

SMALL RAMP

Number of parts	3
Total length	ca. 3,20 m
Hand rail	possible

LOAD PARAMETERS

Dimensions (without euro-pallet)	1,13 x 1,97 x 0,24 m
Weight / volume (without euro-pallet)	200 kg / 0,53 m ³

BIG RAMP

Number of parts	3
Total length	ca. 3,20 m
Hand rail	possible

LOAD PARAMETERS

Dimensions (without euro-pallet)	1,63 x 1,97 m x 0,24 m
Weight / volume (without euro-pallet)	250 kg / 0,77 m ³

SMALL AND BIG FLOOR SYSTEM TUNNEL, top view:

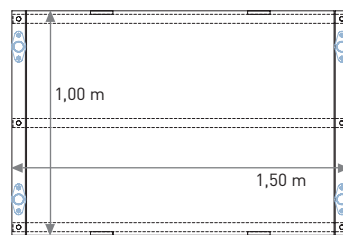
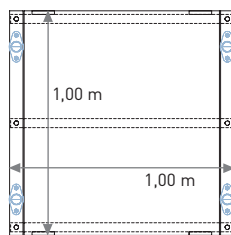

TUNNEL:

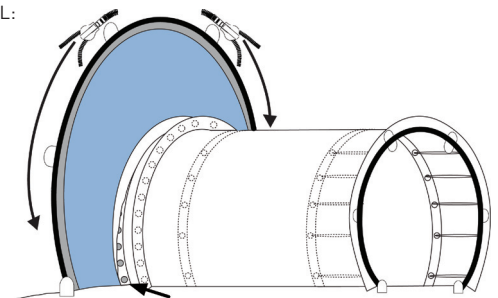

SMALL FLOOR SYSTEM TUNNEL

Number of parts	1
Total length	1 m
Hand rail	possible

LOAD PARAMETERS

Dimensions (without euro-pallet)	1,00 x 1,00 x 0,12 m
Weight / volume (without euro-pallet)	41 kg / 0,12 m ³

BIG FLOOR SYSTEM TUNNEL

Number of parts	1
Total length	1 m
Hand rail	possible

LOAD PARAMETERS

Dimensions (without euro-pallet)	1,00 x 1,50 x 0,12 m
Weight / volume (without euro-pallet)	51 kg / 0,18 m ³

TUNNEL

Membrane of tunnel	polyester fabric (PVC coated)
Reduction	polyester fabric (PVC coated)
Attachment of tunnel	Touch fastener, tightening straps

© ZENDOME 2006-2010. We kindly ask for your understanding that files and content is legal property of ZENDOME GmbH. You are not allowed to transfer data or content to third parties nor copying files and content without written permission of ZENDOME GmbH.

NOTES:

- Presented drawings are to express system and deviate in reality. All sizes, weights and volumes listed in this table are rounded approximations and may deviate due to varying materials or production processes.



ZENDOME / HOME-EDITION, MODULAR / LOGISTIC & STORAGE

The stackable transport stanchions offer perfect protection for the structure system and guarantee the longevity of the entire system.

ZENVISION GmbH

Prenzlauer Promenade 189
D-13198 Berlin
www.zenvision.de

T +49 30 473 776 20
F +49 30 473 776 29
info@zenvision.de

SMALL FRAME STANCHION, longitudinal section:

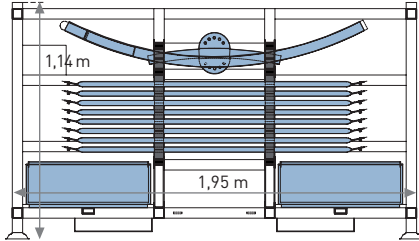

SMALL FRAME STANCHION

Dimensions	2,02 x 0,87 x 1,14 m
Weight / volume	90 kg / 2,00 m ³

SMALL FRAME STANCHION, cross section:

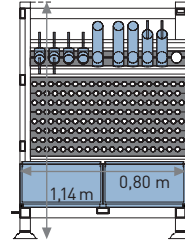

TRANSPORT BOXES

1 x big box	0,80 x 0,60 x 0,22 m
2 x small boxes	0,60 x 0,40 x 0,22 m

BIG FRAME STANCHION, longitudinal section:

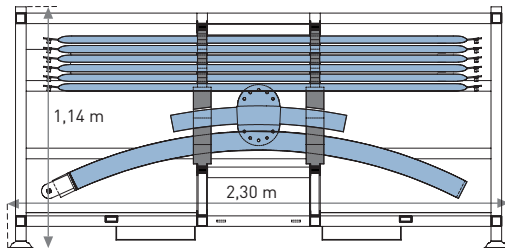

BIG FRAME STANCHION

Dimensions	2,37 x 0,87 x 1,14 m
Weight / volume	98 kg / 2,35 m ³

BIG FRAME STANCHION, cross section:

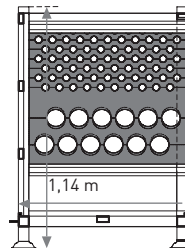

TRANSPORT BOXES

1 x big box	0,80 x 0,60 x 0,22 m
2 x small boxes	0,60 x 0,40 x 0,22 m

FLOOR STANCHION, longitudinal section:

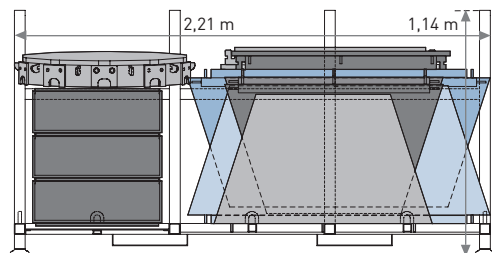

FLOOR STANCHION

Dimensions	2,28 x 1,22 x 1,14 m
Weight / volume	108 kg / 3,17 m ³

FLOOR STANCHION, cross section:

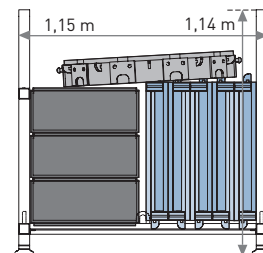

TRANSPORT BOXES

8 x boxes	0,60 x 0,40 x 0,22 m
-----------	----------------------

NOTE:

- Presented drawings are to express system and deviate in reality. All sizes, weights and volumes listed in this table are rounded approximations and may deviate due to varying materials or production processes.



ZENDOME / HOME-EDITION, MODULAR / LOGISTIC & STORAGE
Ideal protection and practical work flow by providing the possibility to lift the membrane in and out of the box directly with the crane.

ZENVISION GmbH Prenzlauer Promenade 189 T +49 30 473 776 20
D-13198 Berlin www.zenvision.de F +49 30 473 776 29
info@zenvision.de

SMALL MEMBRANE BOX, longitudinal section:

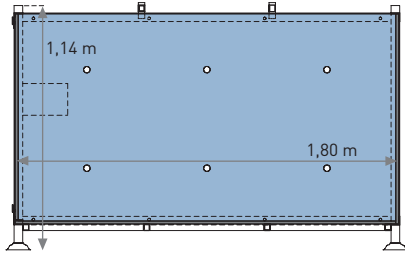

SMALL MEMBRANE BOX, cross section:

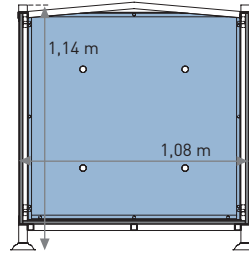

SMALL MEMBRANE BOX

Dimensions	1,15 x 1,875 x 1,14 m
Weight / volume	110 kg / 2,45 m ³

LARGE MEMBRANE BOX, cross section:

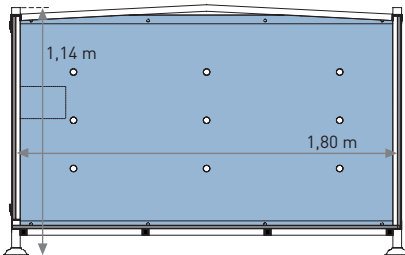

LARGE MEMBRANE BOX, floor plan:

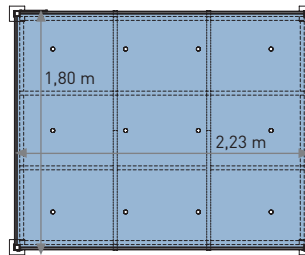

LARGE MEMBRANE BOX

Dimensions	2,30 x 1,875 x 1,14 m
Weight / volume	250 kg / 4,91 m ³

NOTE:

- Presented drawings are to express system and deviate in reality. All sizes, weights and volumes listed in this table are rounded approximations and may deviate due to varying materials or production processes.



ZENDOME / HOME-EDITION, MODULAR / LOGISTIC & STORAGE
The entire system for the safe and easy transport. With our special adapter you will grab anything you might need for the ZENDOME.doors.

ZENVISION GmbH Prenzlauer Promenade 189 T +49 30 473 776 20
D-13198 Berlin F +49 30 473 776 29
www.zenvision.de info@zenvision.de

DOOR STANCHION, longitudinal section:

DOOR STANCHION, cross section:

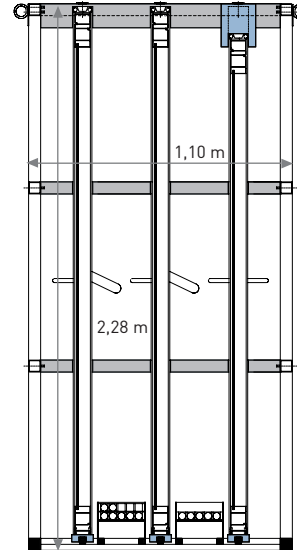
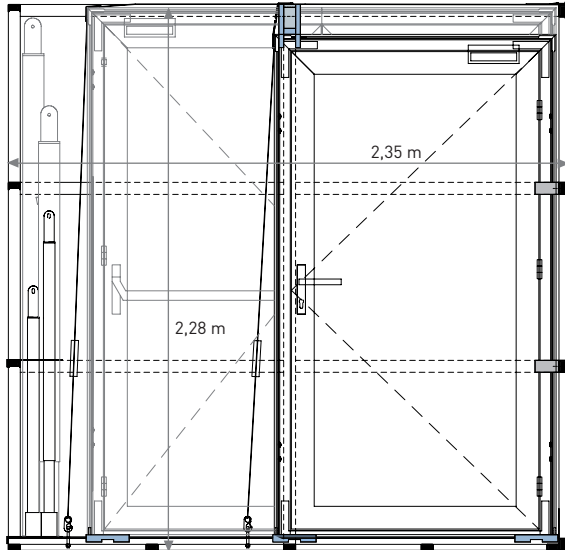

DOOR STANCHION

Dimensions	2,35 x 1,10 x 2,28 m
Weight / volume	ca. 290 kg / 5,89 m ³

NOTE:

- Presented drawings are to express system and deviate in reality. All sizes, weights and volumes listed in this table are rounded approximations and may deviate due to varying materials or production processes.