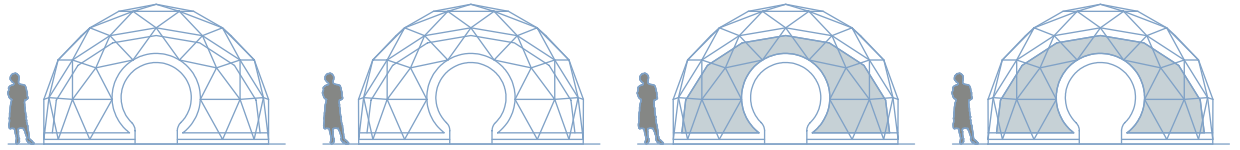
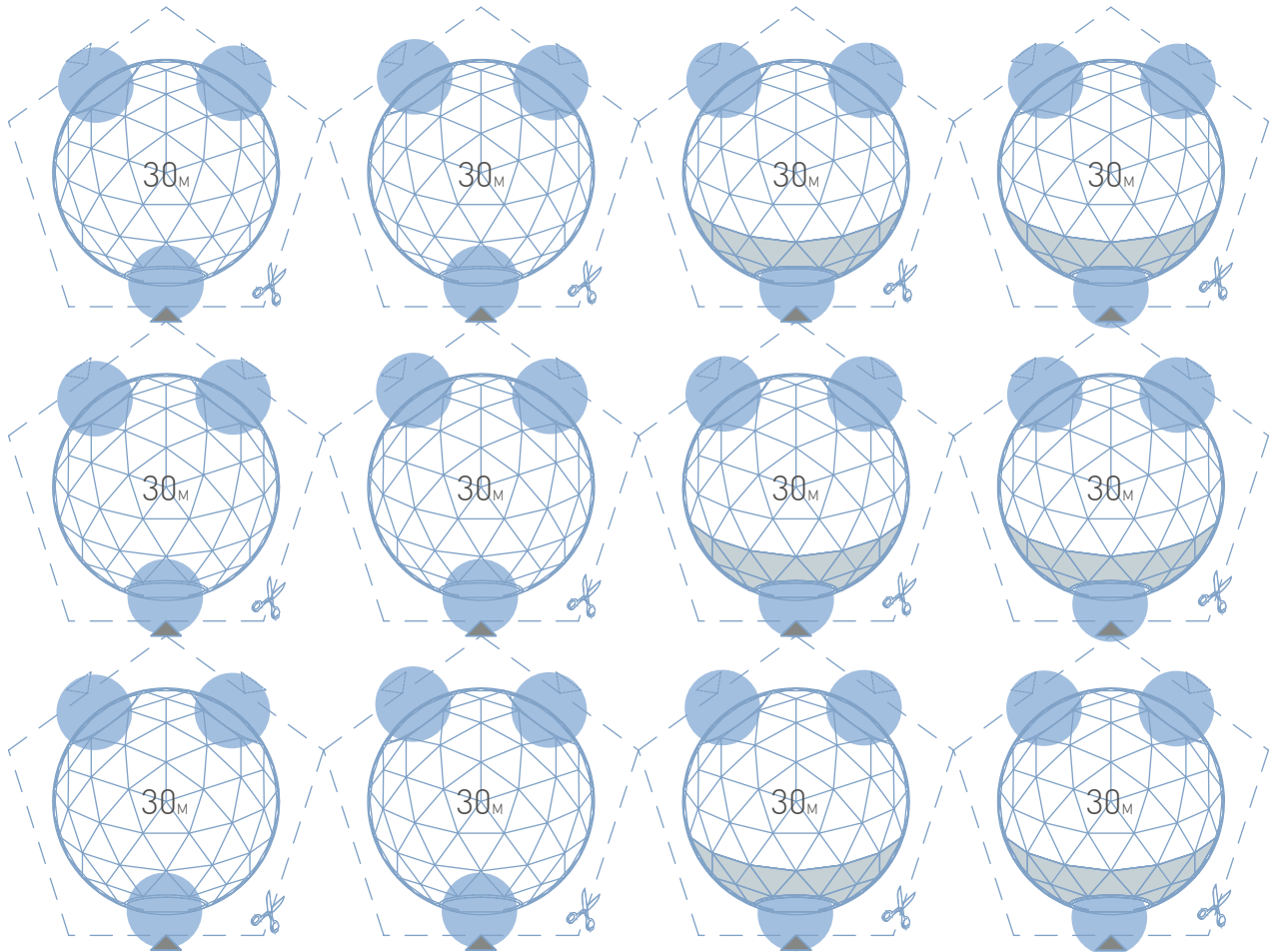
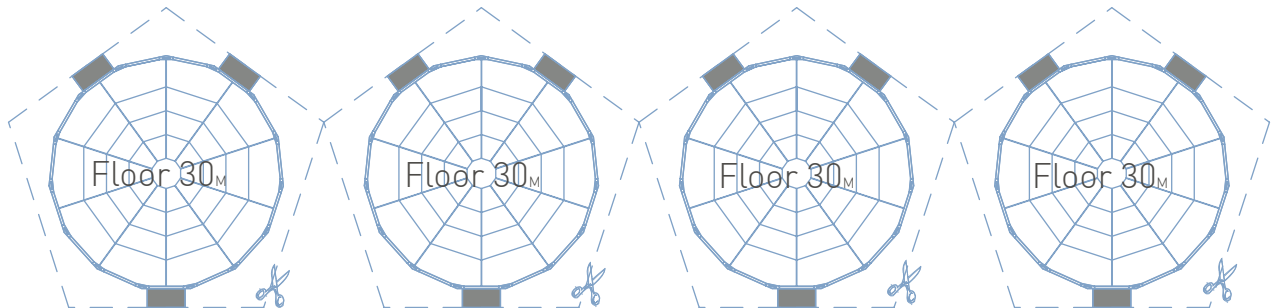
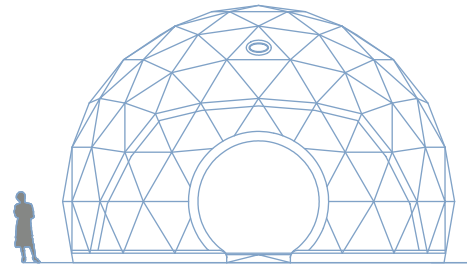
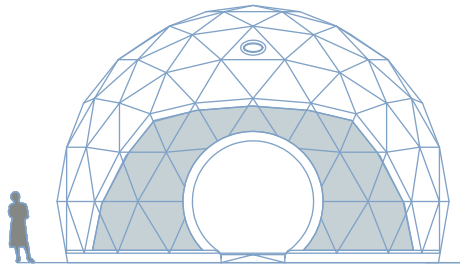

ZENDOME. planning model scale 1:200

ZENDOME. views with / without panorama window

ZENDOME. floor plan with / without panorama window

ZENDOME. floor-system with tunnel connectors

TECHNICAL DATA	
Diameter	6,29m
Height	3,85m
Exhibition Space	30m ²
Membrane Surface	66m ²
Volume	70m ³

NOTE
 Just cut the pieces along the dotted lines. To simplify things the ZENDOMES are located on top of pentagons. Arrows pointing to the circular doorways and forming the Y-structure. Please note that, in real dimensions, 1cm is equivalent to 2m.

ZENDOME. planning model scale 1:200



ZENDOME. views with / without panorama window

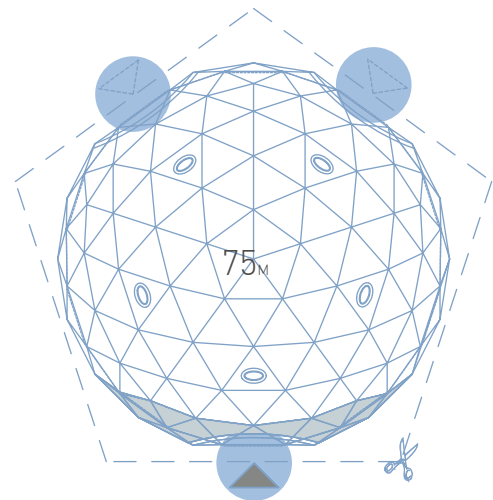
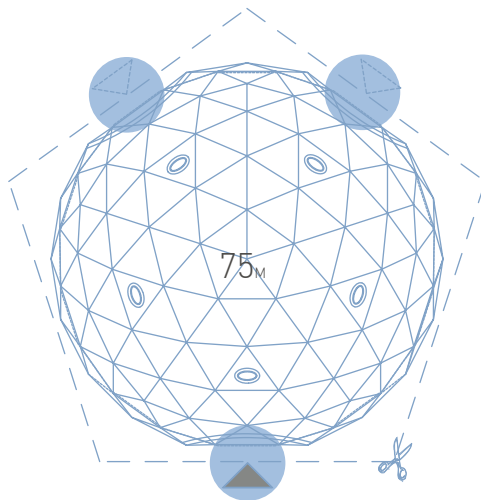

ZENDOME. floor plan with / without panorama window

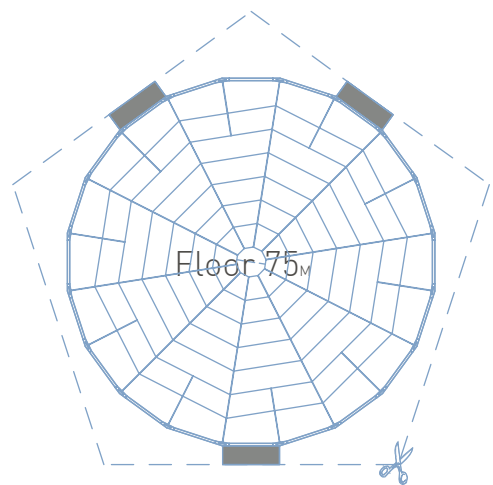
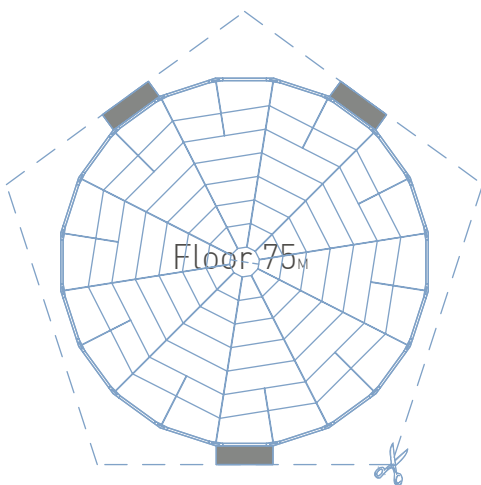

ZENDOME. floor-system with tunnel connectors

TECHNICAL DATA	
Diameter	9,84m
Height	6,80m
Exhibition Space	74,9m ²
Membrane Surface	209m ²
Volume	250m ³

NOTE
 Just cut the pieces along the dotted lines. To simplify things the ZENDOMEs are located on top of pentagons. Arrows pointing to the circular doorways and forming the Y-structure. Please note that, in real dimensions, 1cm is equivalent to 2m.



ZENDOME. planning model scale 1:200

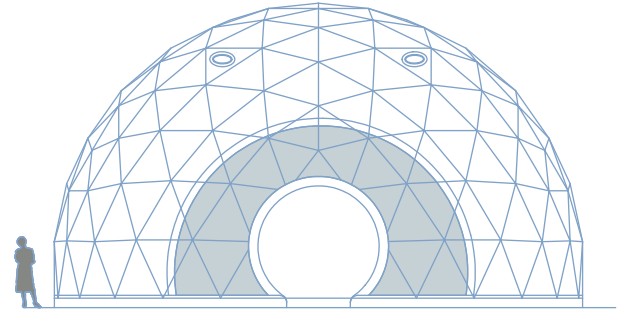
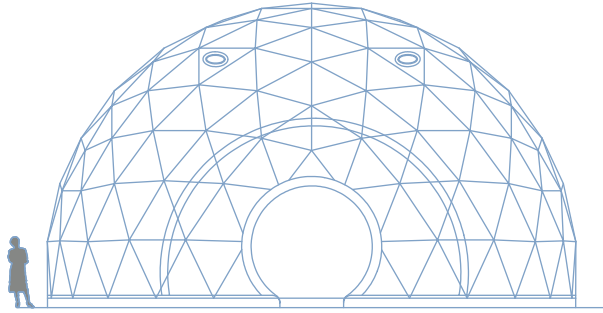

ZENDOME. views with / without panorama window

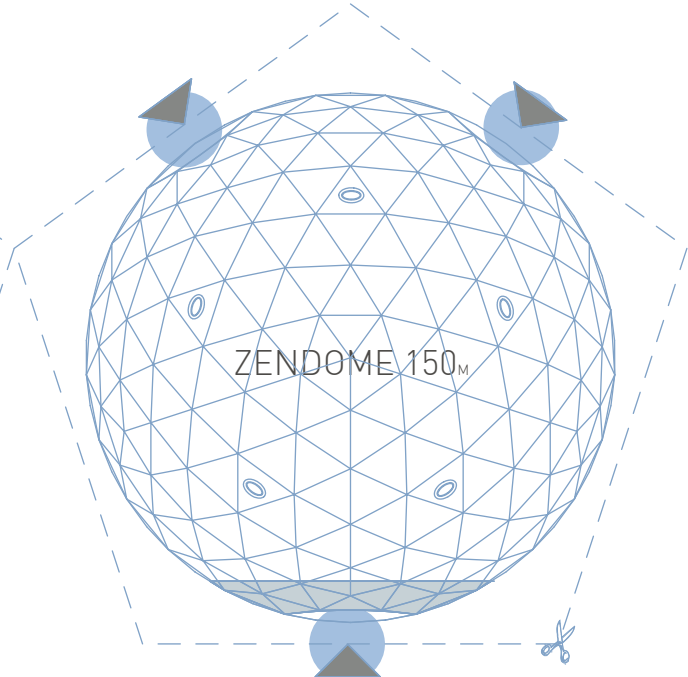
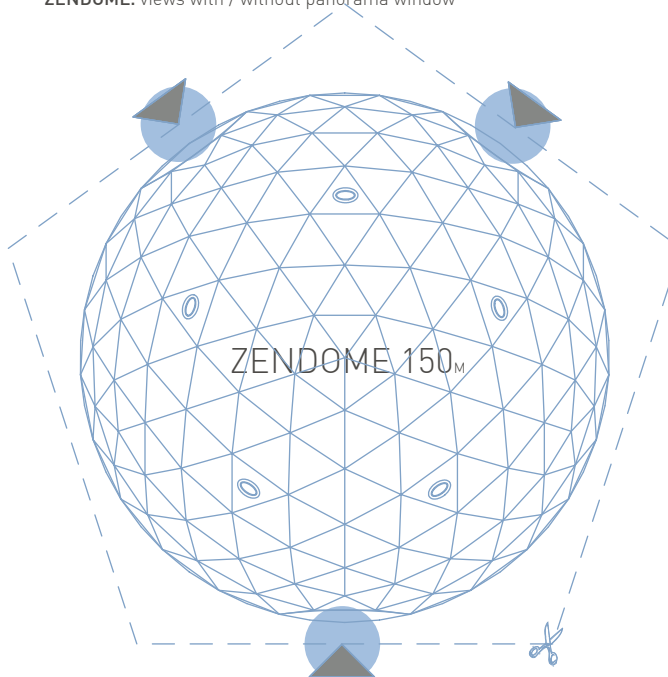

ZENDOME. floor plan with / without panorama window

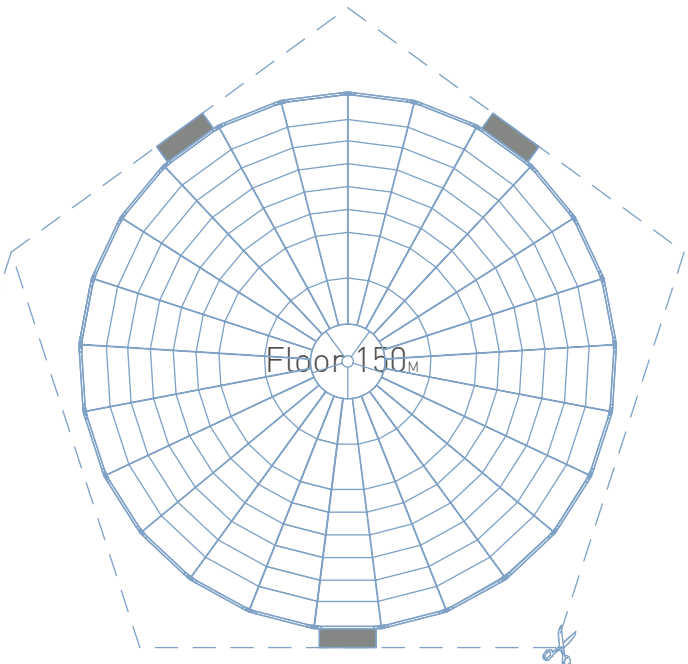
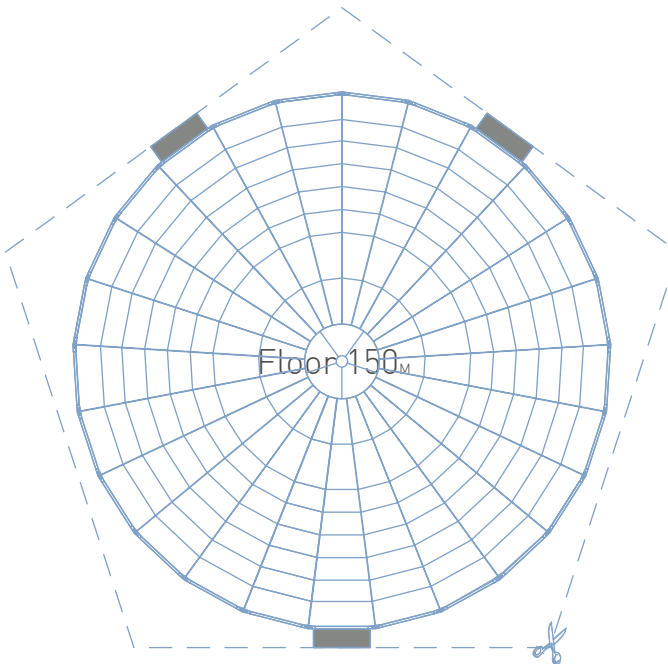

TECHNICAL DATA	
Diameter	14,00m
Heigth	8,05m
Exhibition Space	150m ²
Membrane Surface	294m ²
Volume	700m ³

NOTE
Just cut the pieces along the dotted lines. To simplify things the ZENDOMEs are located on top of pentagons. Arrows pointing to the circular doorways and forming the Y-structure. Please note that, in real dimesions, 1cm is equivalent to 2m.

ZENDOME. planning model scale 1:200

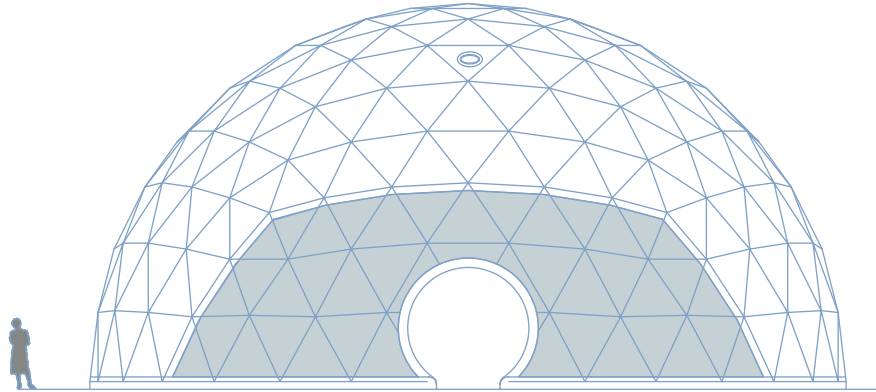

ZENDOME. view with panorama window

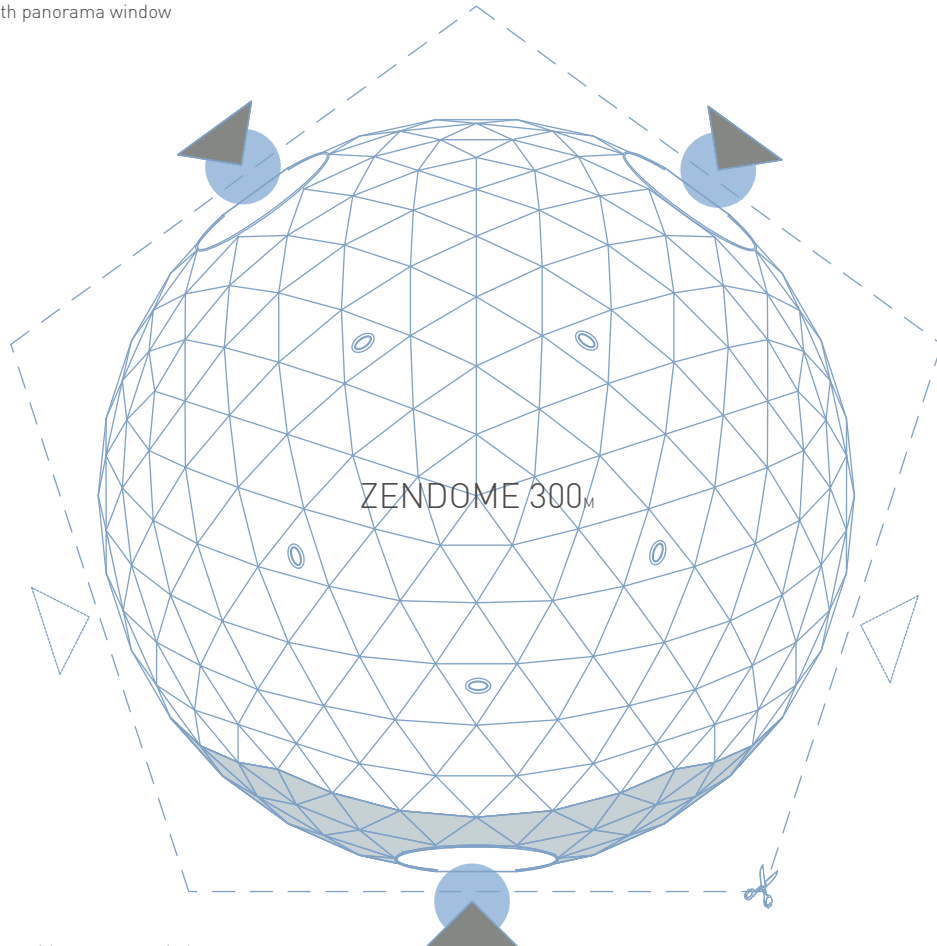

ZENDOME. floor plan with panorama window

TECHNICAL DATA	
Diameter	20,00m
Heigth	10,00m
Exhibition Space	300m ²
Membrane Surface	620m ²
Volume	2.100m ³

NOTE
 Just cut the pieces along the dotted lines. To simplify things the ZENDOMEs are located on top of pentagons. Arrows pointing to the circular doorways and forming the Y-structure. Please note that, in real dimesions, 1cm is equivalent to 2m.

ZENDOME. planning model scale 1:200

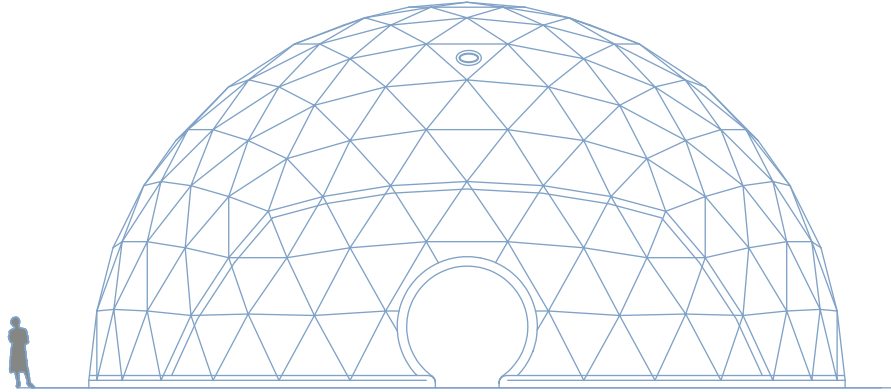

ZENDOME. view without panorama window

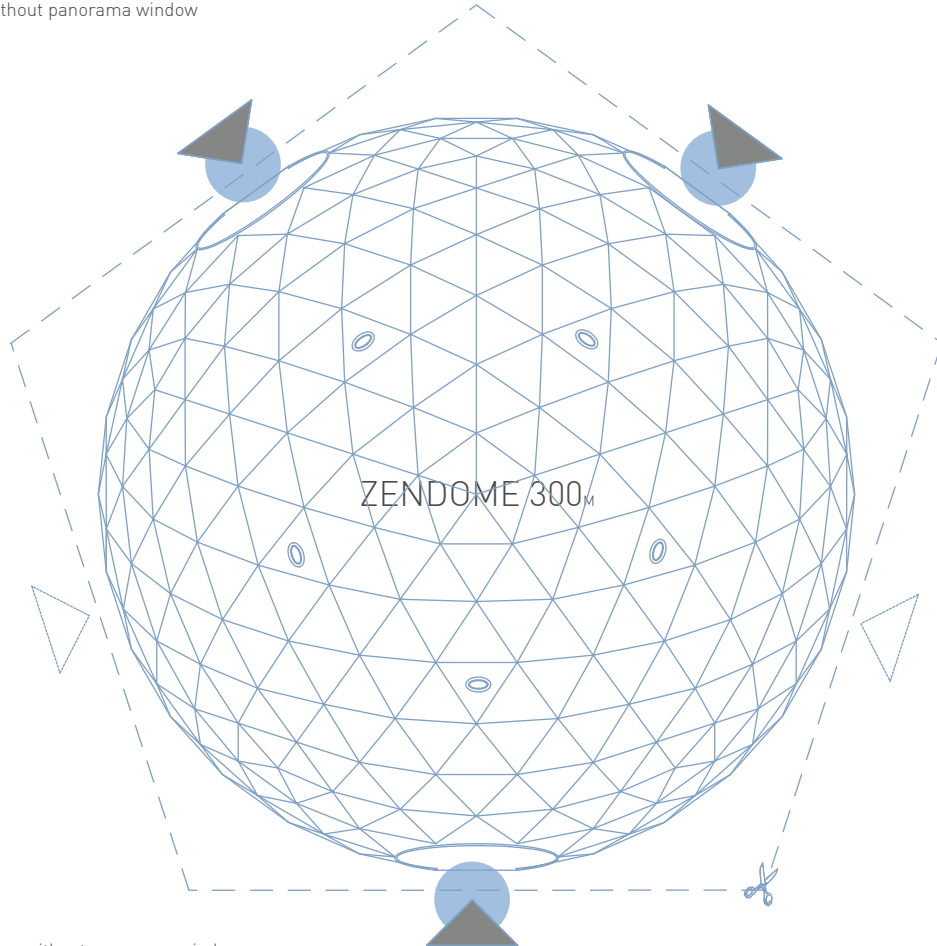

ZENDOME. floor plan without panorama window

TECHNICAL DATA	
Diameter	20,00m
Heigth	10,00m
Exhibition Space	300m ²
Membrane Surface	620m ²
Volume	2.100m ³

NOTE
 Just cut the pieces along the dotted lines. To simplify things the ZENDOMEs are located on top of pentagons. Arrows pointing to the circular doorways and forming the Y-structure. Please note that, in real dimesions, 1cm is equivalent to 2m.

ZENDOME. planning model scale 1:200

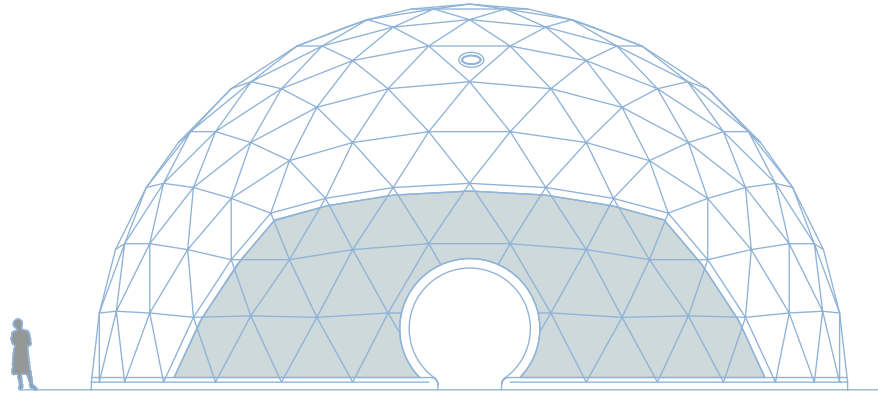

ZENDOME. view with panorama window

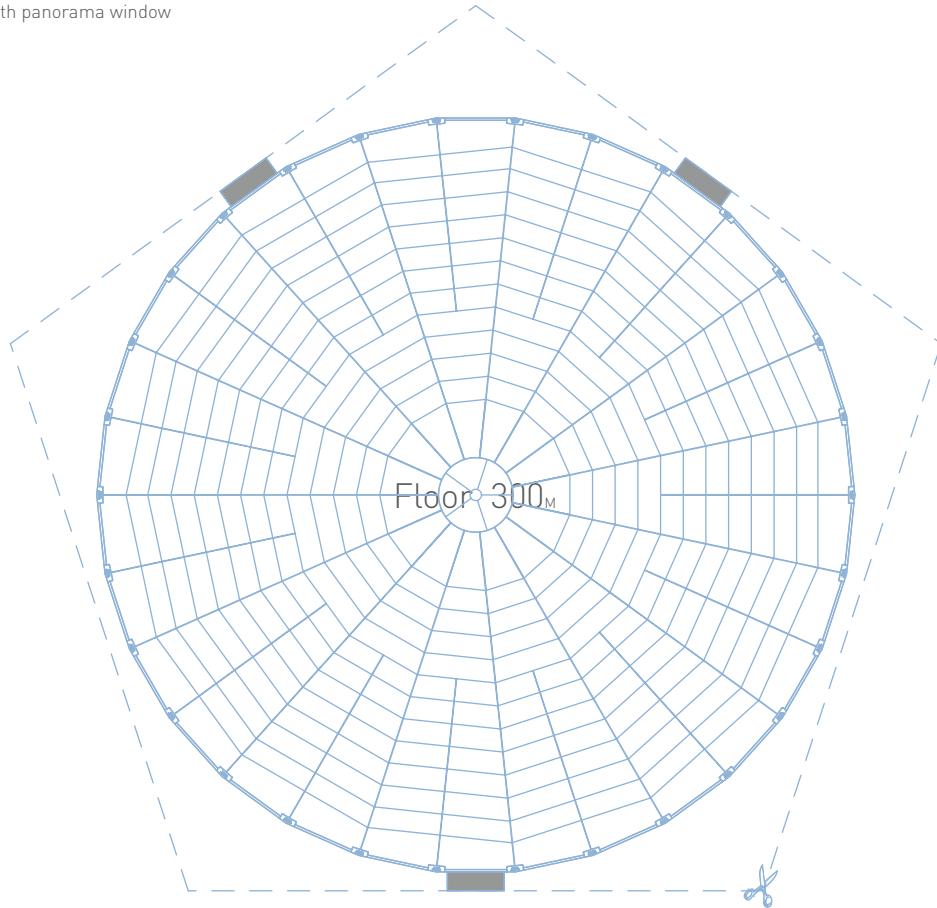

ZENDOME. floor-system with tunnel connectors

TECHNICAL DATA	
Diameter	20,00m
Heigth	10,00m
Exhibition Space	300m ²
Membrane Surface	620m ²
Volume	2.100m ³

NOTE
 Just cut the pieces along the dotted lines. To simplify things the ZENDOMEs are located on top of pentagons. Arrows pointing to the circular doorways and forming the Y-structure. Please note that, in real dimesions, 1cm is equivalent to 2m.

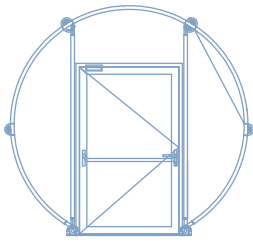
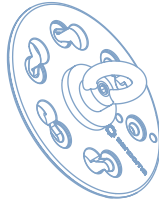
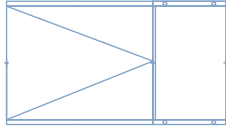
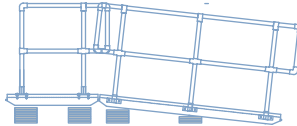
ZENDOME.add-ons (without scale)

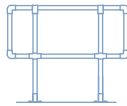
ZENDOMEdoor-systems

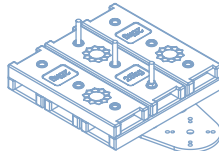
ZENDOME.plugin

ZENDOME.ramps

Railing for Ramps

ZENDOME.tunnel connector (floor)

Railing for connector

ZENDOME.weights 25kg

External Loads

More information about ZENDOME.add-ons are available on our web site: www.zendome.com/add-ons

Additional Tool-kit

Emergency Exit

Fire Extinguisher

Smokers Area

Electricity Supply

Water Supply
SECURITY

Security comes first! By choosing ZENDOME you not only have selected the original but also quality Made in Germany, safety and service. You will get longevity and a perfect fit. Please check with regional regulations and official organizations.

Heating System (oil) 100KW 1:200 (Example)

A/C 200KW 1:200 (example)

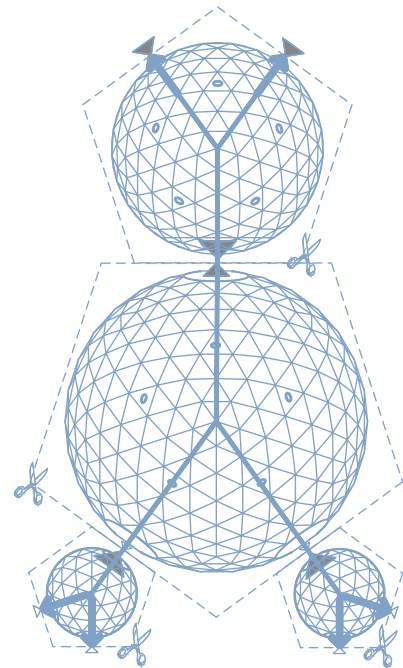
WC Container 1:200 (6 toilets 6mx2,5m)
ZENDOME.domescape

NOTE

The basic form of the ZENDOME is a "pentagon". Each ZENDOME is designed to have 3 openings in the membrane; this gives you the option to connect with other units in order to build a ZENDOME.domescape (Y-Systematik). For different set-ups and special requests, please do challenge us!